

Product Overview

The CMD285C3 is DC to 20 GHz GaAs MMIC absorptive Voltage Variable Attenuator (VVA) housed in a leadless surface mount package ideally suited for military, space and communications systems. The VVA uses two analog control voltages varied between -5 V and 0 V to control RF signal levels over a 35 dB dynamic range. The CMD285C3 has a low insertion loss of 3.2 dB at 10 GHz and is a 50 ohm matched design, eliminating the need for RF port matching.

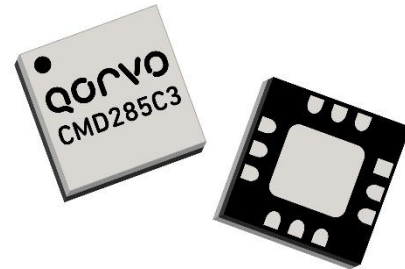

Functional Block Diagram

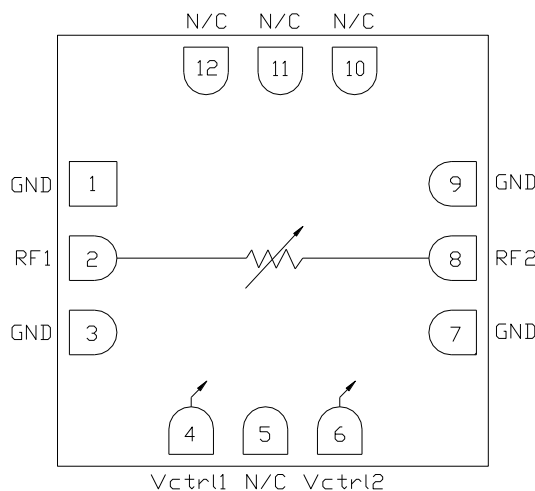

Key Features

- Wideband Performance
- Low Insertion Loss
- Wide Attenuation Range
- High Linearity
- Pb-Free RoHs Compliant 3x3 mm SMT Package

Ordering Information

Part No.	Description
CMD285C3	DC-20 GHz Voltage-Variable Attenuator, 100 Piece 7" Reel
CMD285C3-EVB	Evaluation Board

Electrical Performance ($V_{ctrl1} = 0\text{ V}$, $V_{ctrl2} = -5.0\text{ V}$, $T_A = 25\text{ }^\circ\text{C}$, $F = 10\text{ GHz}$)

Parameter	Min	Typ	Max	Units
Frequency Range		DC - 20		GHz
Insertion Loss		3.2		dB
Attenuation Range		33		dB
Return Loss		11		dB
Input P1dB		20		dBm
Input IP3		30		dBm
Input IP2		55		dBm
Switching Characteristics				
tRISE, tFALL (10/90% RF)		10		ns
tON, tOFF (50% CTL to 10/90% RF)		25		ns

Absolute Maximum Ratings

Parameter	Rating
RF Input Power	+27 dBm
Control Voltage Range	+0.3 to -8 V
Channel Temperature (Tch)	150 °C
Power Dissipation (P _{diss})	570 mW
Thermal Resistance, θ_{JC}	112.9 °C/W
Operating Temperature	-40 to 150 °C
Storage Temperature	-55 to 150 °C

Exceeding any one or combination of the maximum ratings may cause permanent damage to the device.

Recommended Operating Conditions

Parameter	Bias Condition
V _{ctl1}	-5 to 0 V @ 0.75 mA Typical
V _{ctl2}	-5 to 0 V @ 0.75 mA Typical

Electrical performance is measured at specific test conditions. Electrical specifications are not guaranteed over all recommended operating conditions.

Electrical Specifications (V_{ctl} = -5.0 V to 0 V, T_A = 25 °C)

Parameter	Min	Typ	Max	Min	Typ	Max	Min	Typ	Max	Units
Frequency Range	DC - 6			DC - 12			DC - 20			GHz
Insertion Loss		2.5	3.2		2.8	3.8		3.5	4.3	dB
Attenuation Range	30	35		28	34		27	34		dB
Return Loss		12			10			10		dB
Input P1dB		18			20			19		dBm
Input P0.1dB		13			15			15		dBm
Input IP3		32			30			28		dBm
Input IP2		60			55			55		dBm
Switching Characteristics										
tRISE, tFALL (10/90% RF)		10			10			10		ns
tON, tOFF (50% CTL to 10/90% RF)		25			25			25		ns

Complementary Control Voltage

Control State	V _{ctrl1} (V)	V _{ctrl2} (V)
1	-5	0
2	-4.5	-0.5
3	-4	-1
4	-3.5	-1.5
5	-3	-2
6	-2.5	-2.5
7	-2	-3
8	-1.5	-3.5
9	-1	-4
10	-0.5	-4.5
11	0	-5

Optimum IP3 Control Voltage Table

Control State	V _{ctrl1} (V)	V _{ctrl2} (V)
1	-5	0
2	-5	-1
3	-5	-1.5
4	-5	-2
5	-5	-2.5
6	-5	-4.5
7	-2.5	-1.5
8	-2	-1
9	-2	-2
10	-0.5	-0.5
11	-1.5	-2.5
12	-0.5	-2.5
13	-1.5	-3
14	-2	-5
15	-1.5	-4.5
16	-1	-5
17	0	-5

Typical Performance

Insertion Loss vs. Temperature; $V_{ctrl1} = 0V$, $V_{ctrl2} = -5.0V$

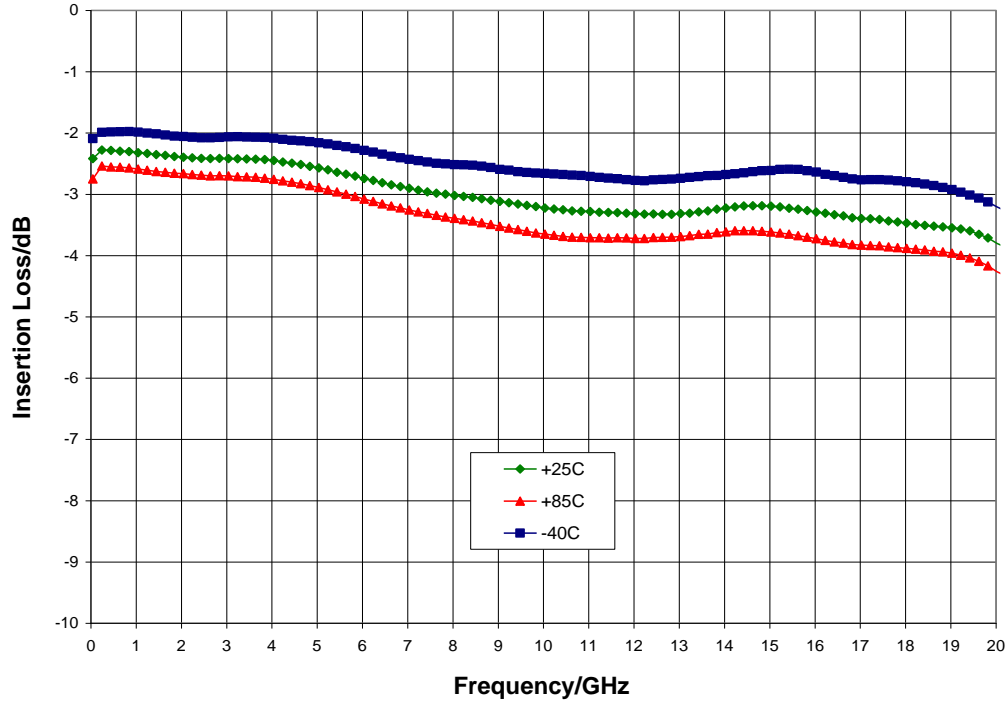

Return Loss vs. Attenuation, $T_A = 25\text{ }^\circ\text{C}$

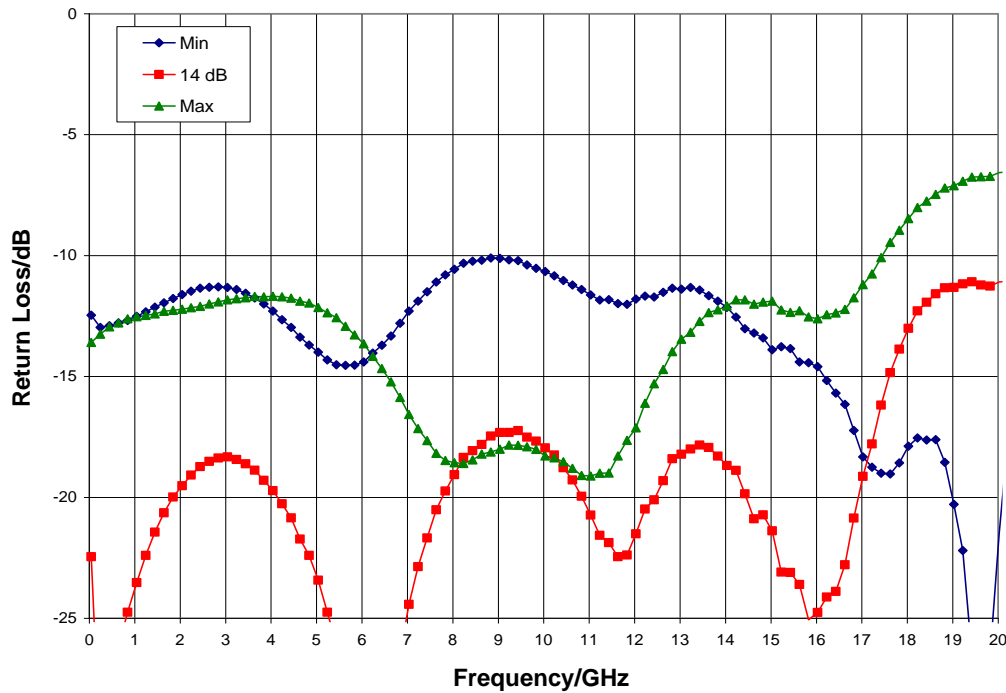

Typical Performance

Relative Attenuation, Complementary Control Voltage Table, $T_A = 25\text{ }^\circ\text{C}$

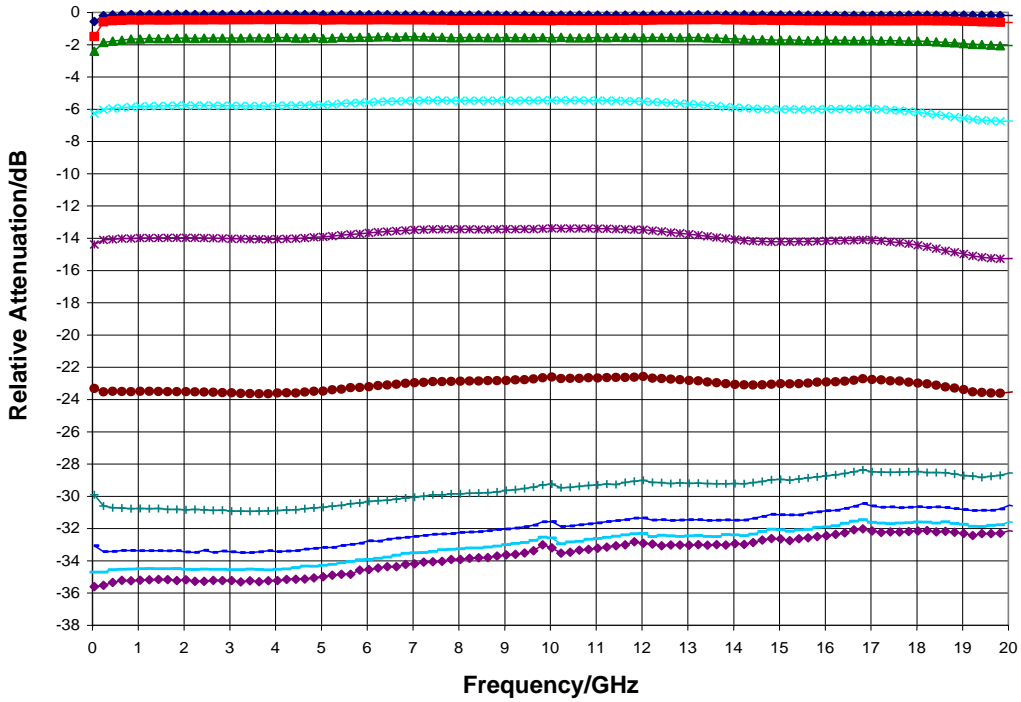

Relative Attenuation, Optimum IP3 Control Voltage Table, $T_A = 25\text{ }^\circ\text{C}$

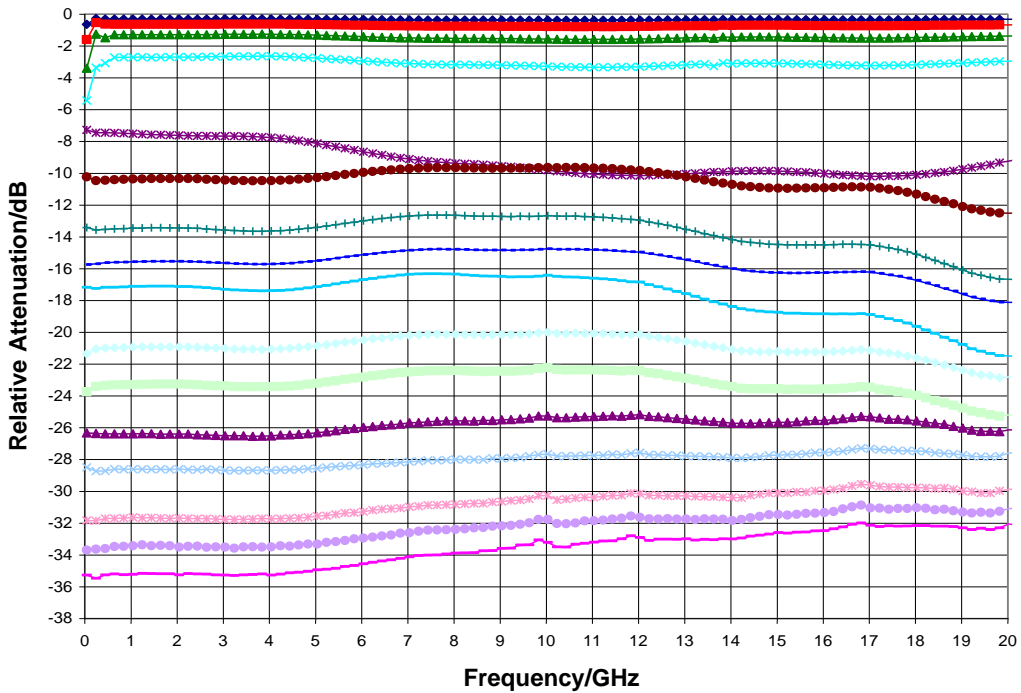

Typical Performance

Relative Attenuation vs. Control Voltage, Complementary Control Voltage Table

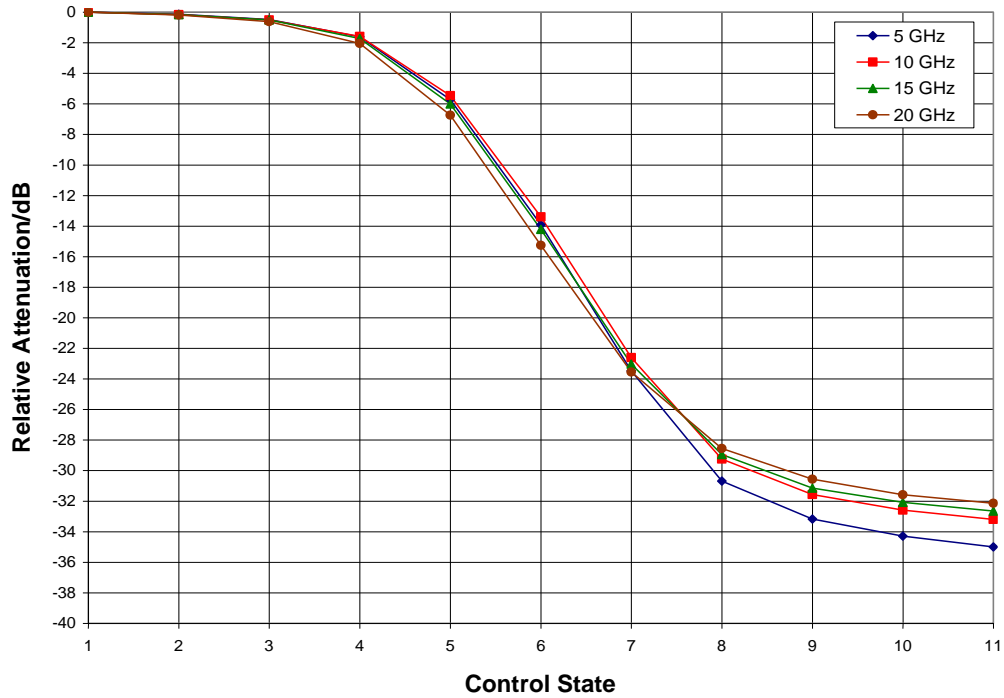

Relative Attenuation vs. Control Voltage, Optimum IP3 Control Voltage Table

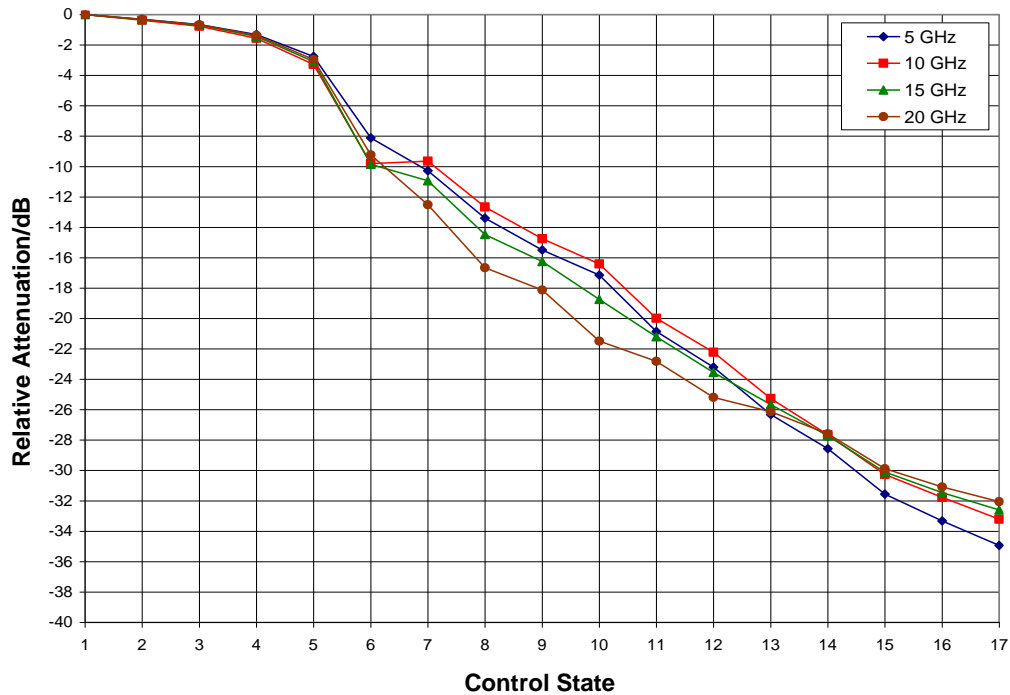

Typical Performance

Relative Phase vs. Attenuation, Complementary Control Voltage Table

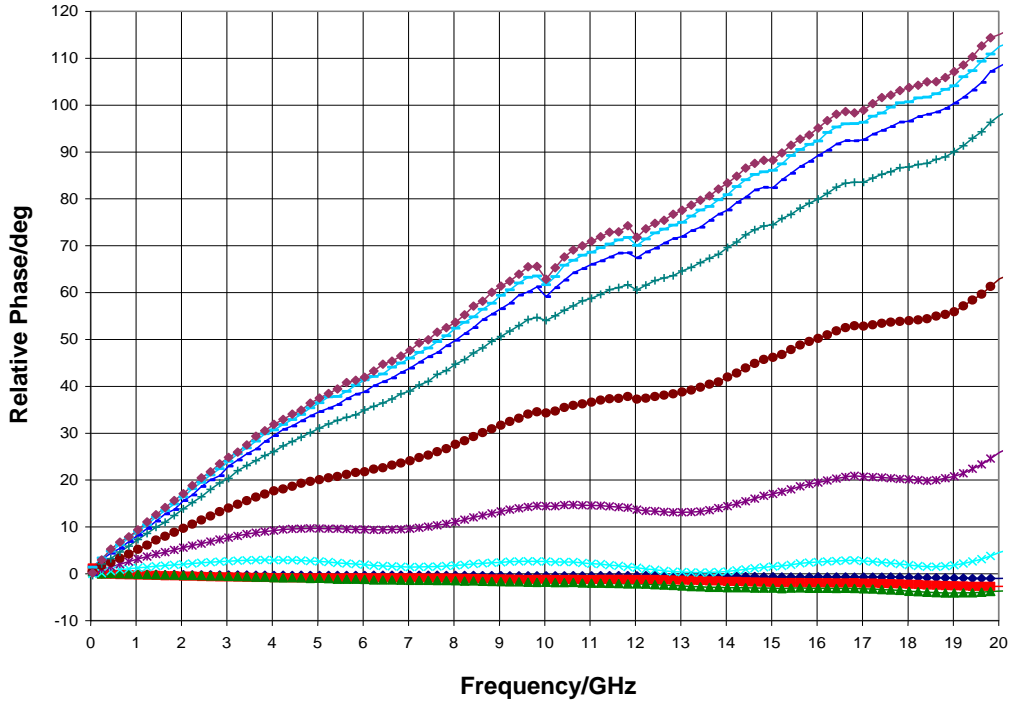

Relative Phase vs. Attenuation, Optimum IP3 Control Voltage Table

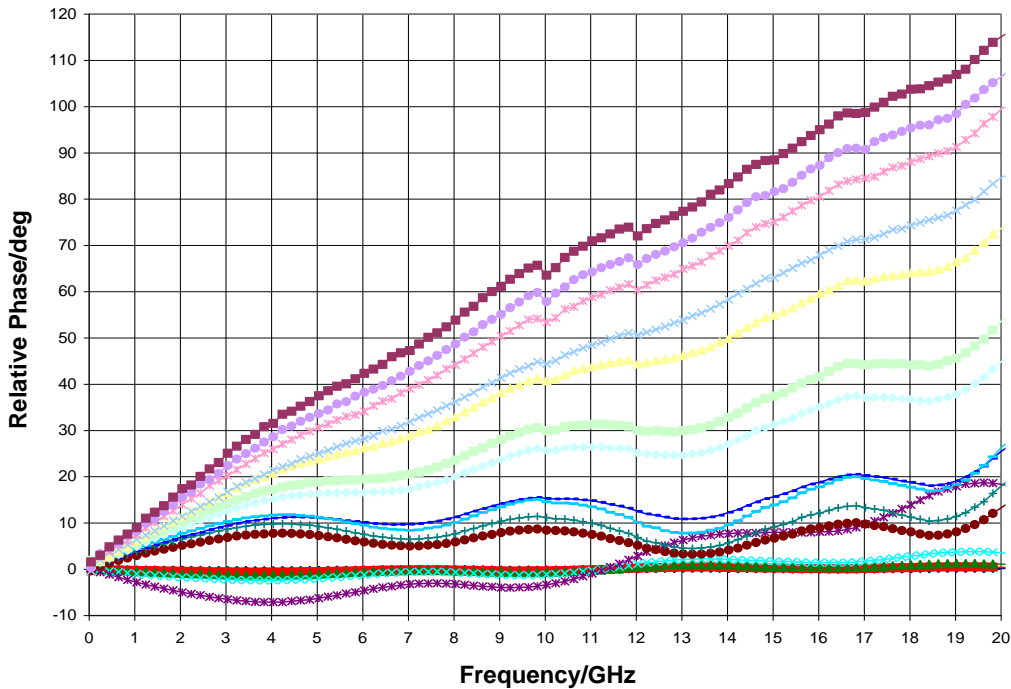

Typical Performance

Input P1dB vs. Temperature, Insertion Loss State; $V_{ctrl1} = 0V$, $V_{ctrl2} = -5.0V$

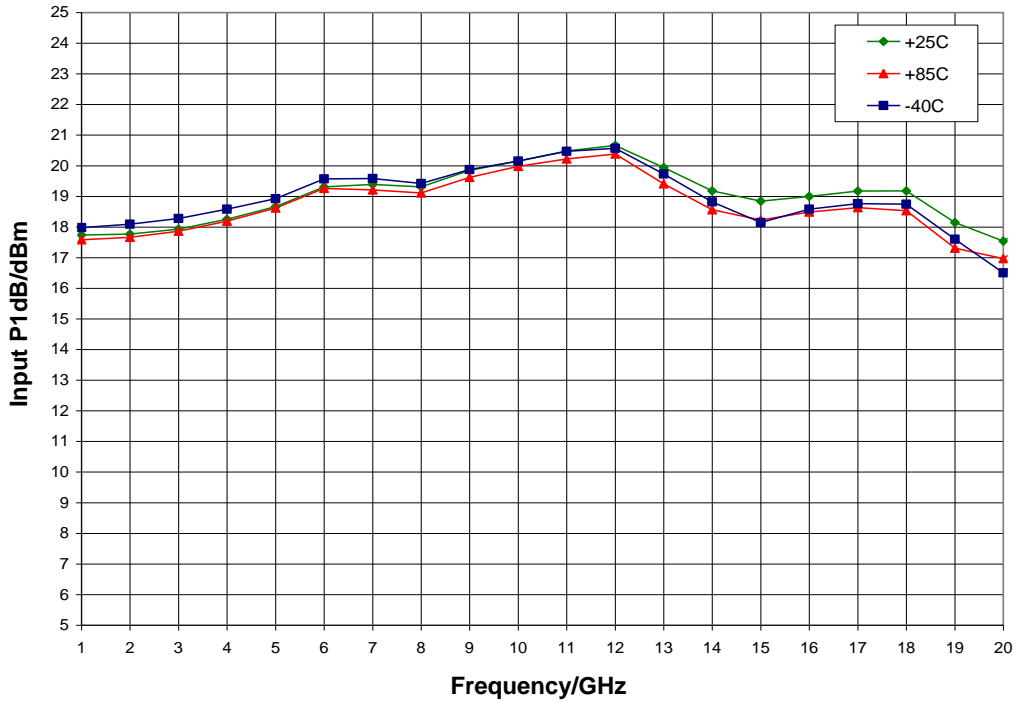

Input P0.1dB vs. Temperature, Insertion Loss State; $V_{ctrl1} = 0V$, $V_{ctrl2} = -5.0V$

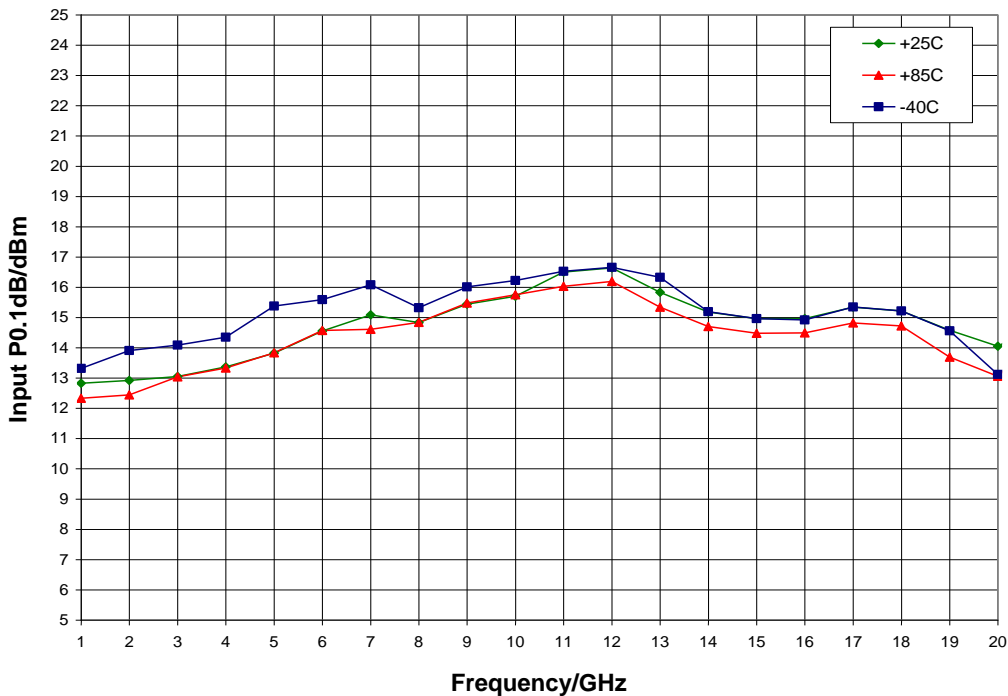

Typical Performance

Input P1dB vs. Temperature, Insertion Loss State; $V_{ctrl1} = 0V$, $V_{ctrl2} = -5.0V$

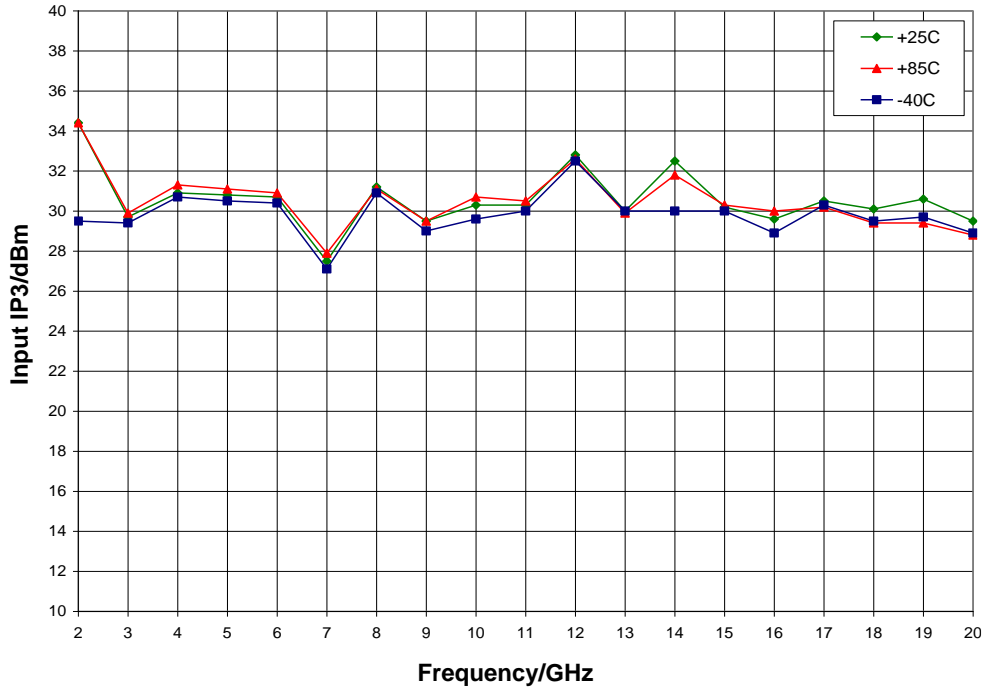

Input IP2 vs. Temperature, Insertion Loss State; $V_{ctrl1} = 0V$, $V_{ctrl2} = -5.0V$

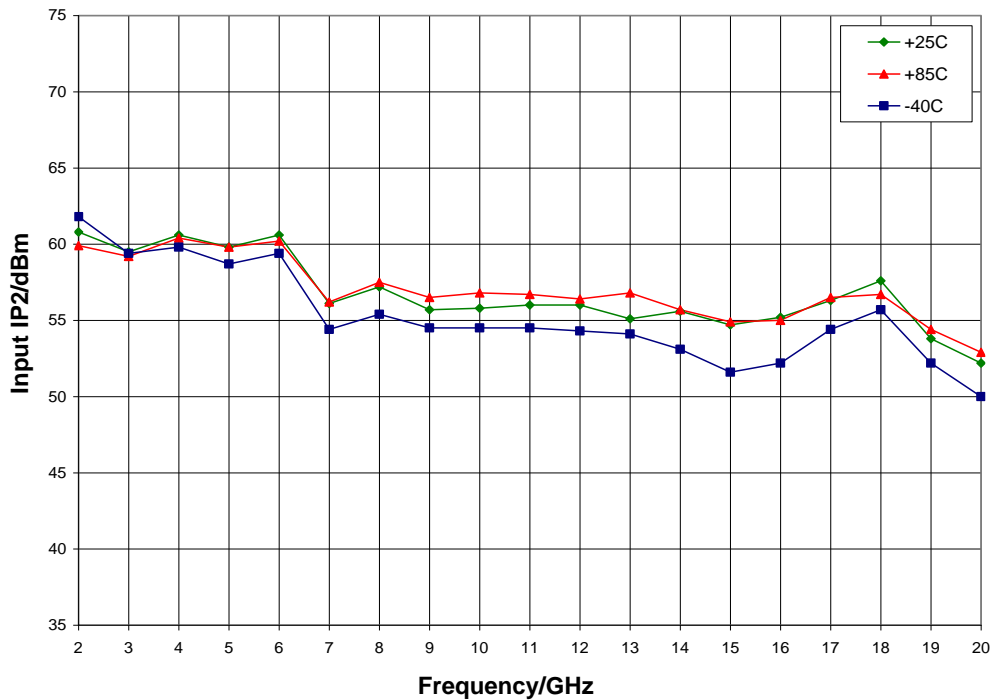

Typical Performance

Input IP3 vs. Attenuation, Complementary Control Voltage Table

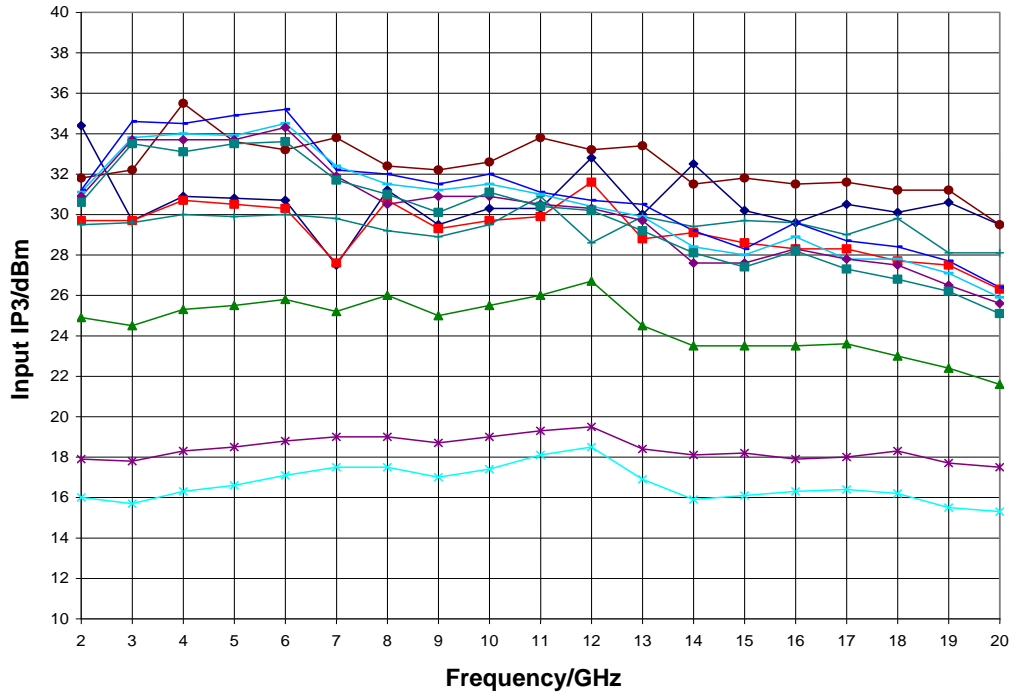

Input IP3 vs. Attenuation, Optimum IP3 Control Voltage Table

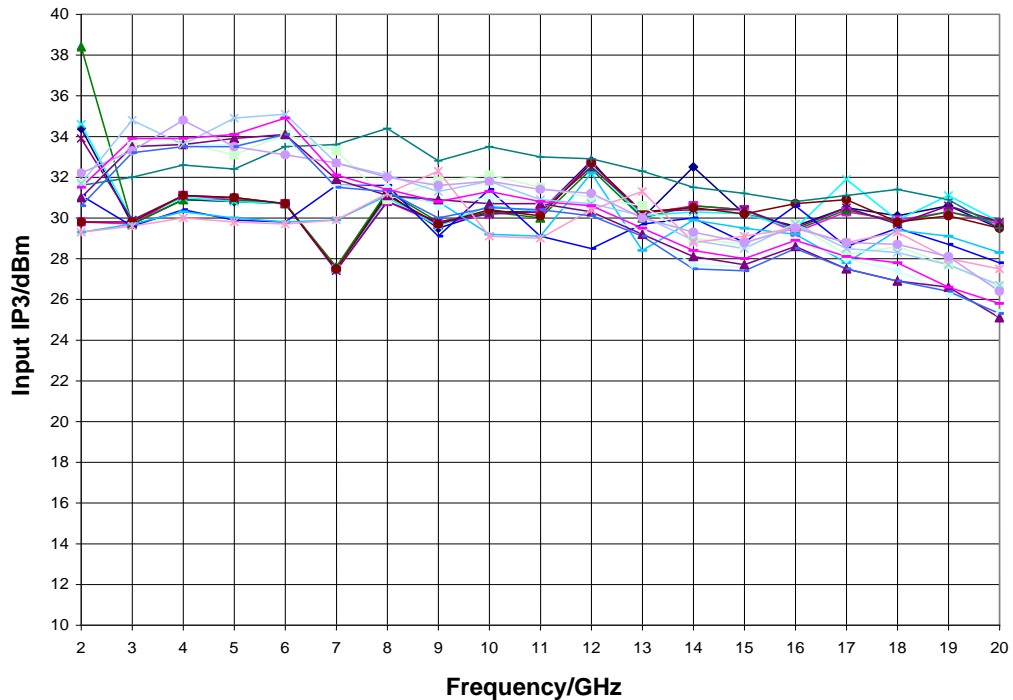

Typical Performance

Input IP3 vs. Attenuation, F = 10 GHz

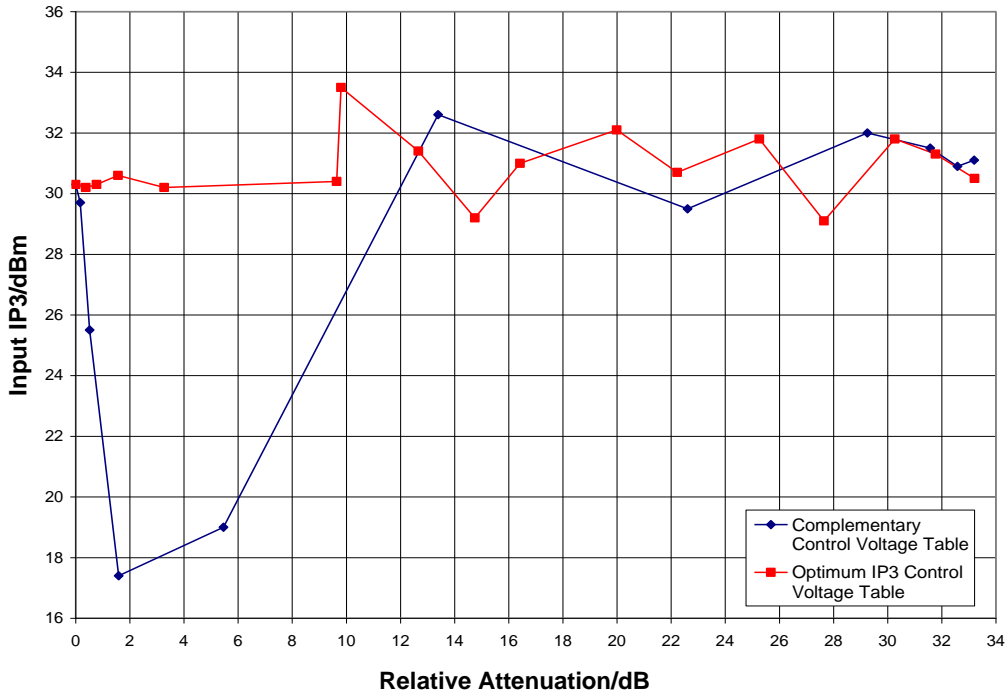

Input IP3 vs. Attenuation, F = 20 GHz

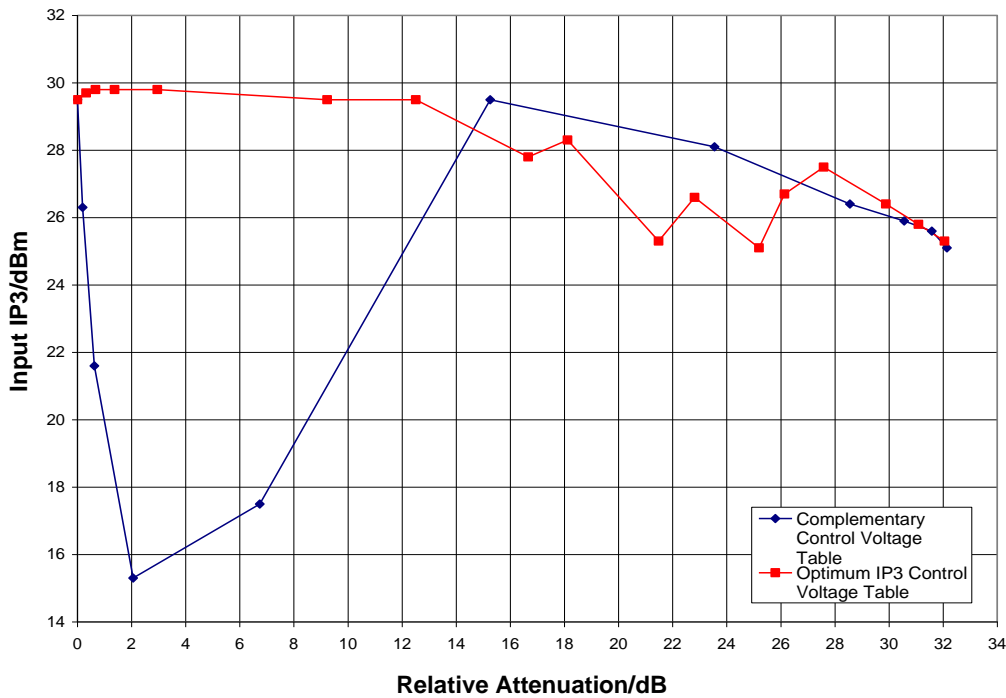

Typical Performance

Input IP2 vs. Attenuation, Complementary Control Voltage Table

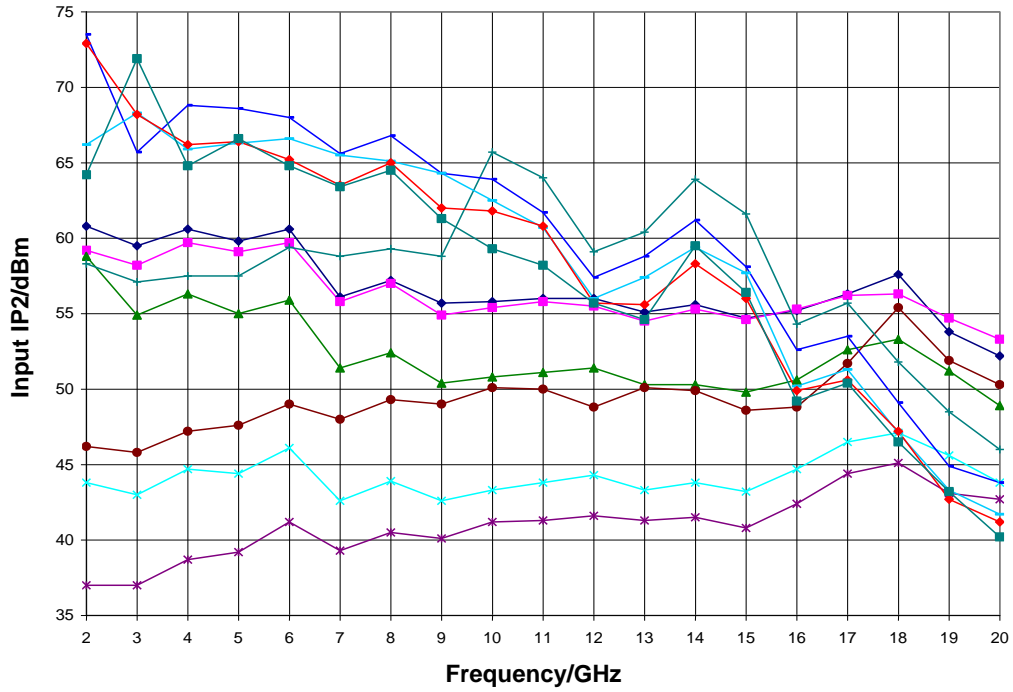

Input IP2 vs. Attenuation, Optimum IP3 Control Voltage Table

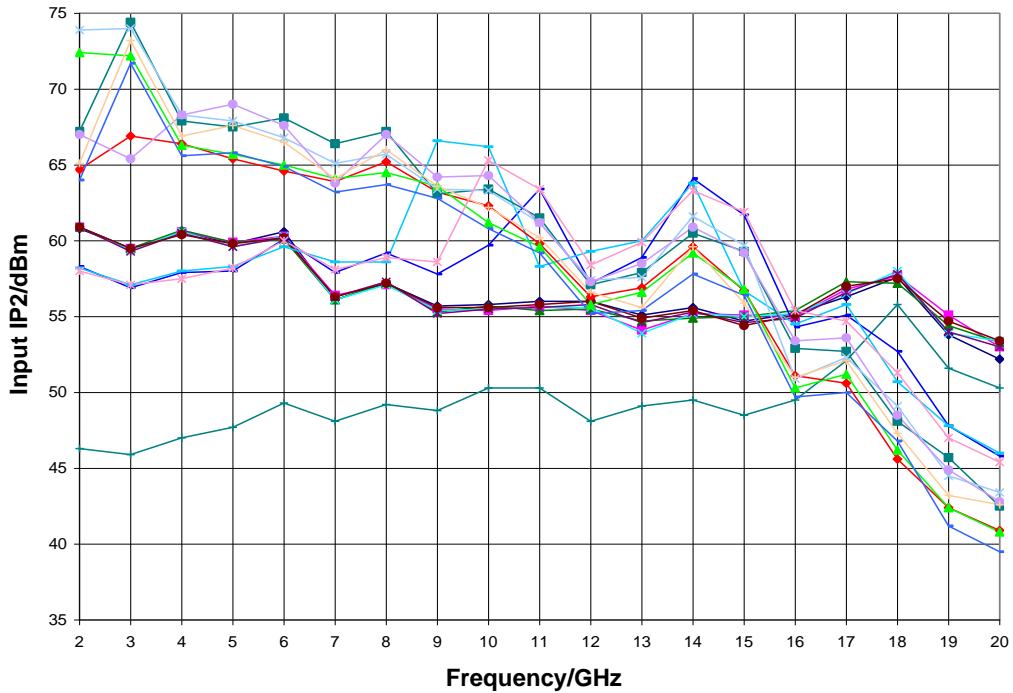

Mechanical Information

Package Information and Dimensions

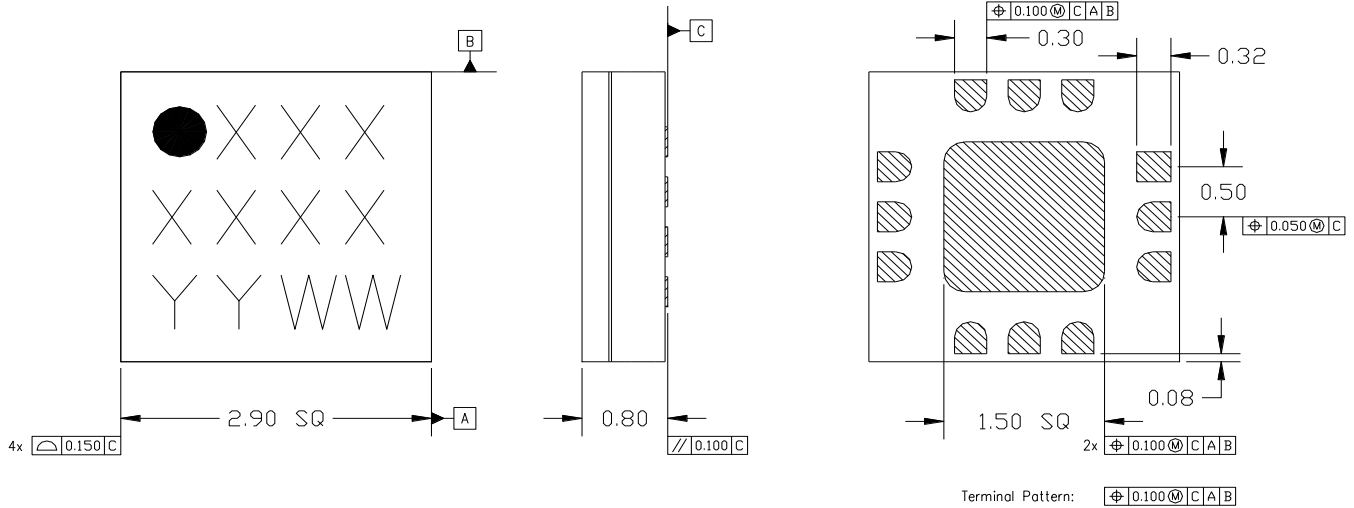

Notes:

1. All dimensions shown in mm.
2. Material: Black alumina
3. Lead finish
 - 3.1. Ni: 8.89um max, 1.27um min
 - 3.2. Pd: 0.17um max, 0.07um min
 - 3.3. Au: 0.254um max, 0.03um min
4. Marking
 - 4.1. Line 1: Part number
 - 4.1.1. Example: CMD285C3 shall be marked as 285
 - 4.2. Line 2: Lot number
 - 4.3. Line 3: Date code - Last 2 digits of the year of manufacture followed by a 2 digit week code
5. Alternate pin #1 identifier is a single square pad
6. Alternate die paddle may have chamfered corners

Recommended PCB Land Pattern

Qorvo recommends that the user develop the land pattern that will provide the best design for proper solder reflow and device attach for their specific application. Please review Qorvo Application Note AN 105 for a recommended land pattern approach.

Recommended Solder Reflow Profile

Qorvo recommends screen printing with belt furnace reflow to ensure proper solder reflow and device attach. Please review Qorvo Application Note AN 102 for a recommended solder reflow profile.

Pin Description

Pin Diagram

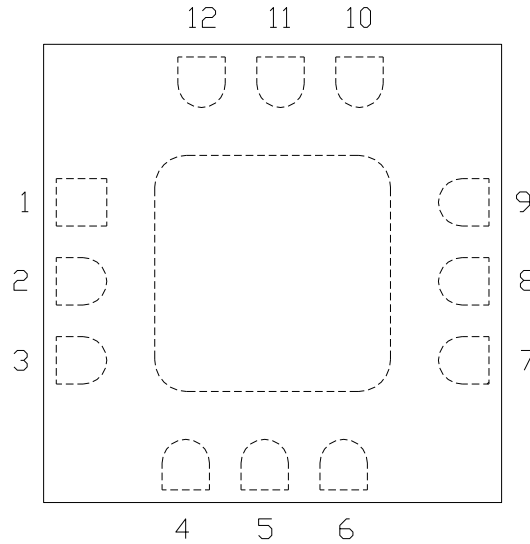

Functional Description

Pad	Function	Description	Schematic
1, 3, 7, 9 and die paddle	Ground	Connect to RF / DC ground	
2	RF in	This pin is DC coupled and matched to 50 ohm Blocking capacitor is required if RF line potential is not equal to 0 V	
8	RF out	This pin is DC coupled and matched to 50 ohm Blocking capacitor is required if RF line potential is not equal to 0 V	
4	V _{ctrl1}	Control voltage 1	
6	V _{ctrl2}	Control voltage 2	
5, 10 - 12	N/C	No connection required These pins may be connected to RF / DC ground	

Applications Information

Evaluation Board

The circuit board shown has been developed for optimized assembly at Qorvo. A sufficient number of via holes should be used to connect the top and bottom ground planes. As surface mount processes vary, careful process development is recommended.

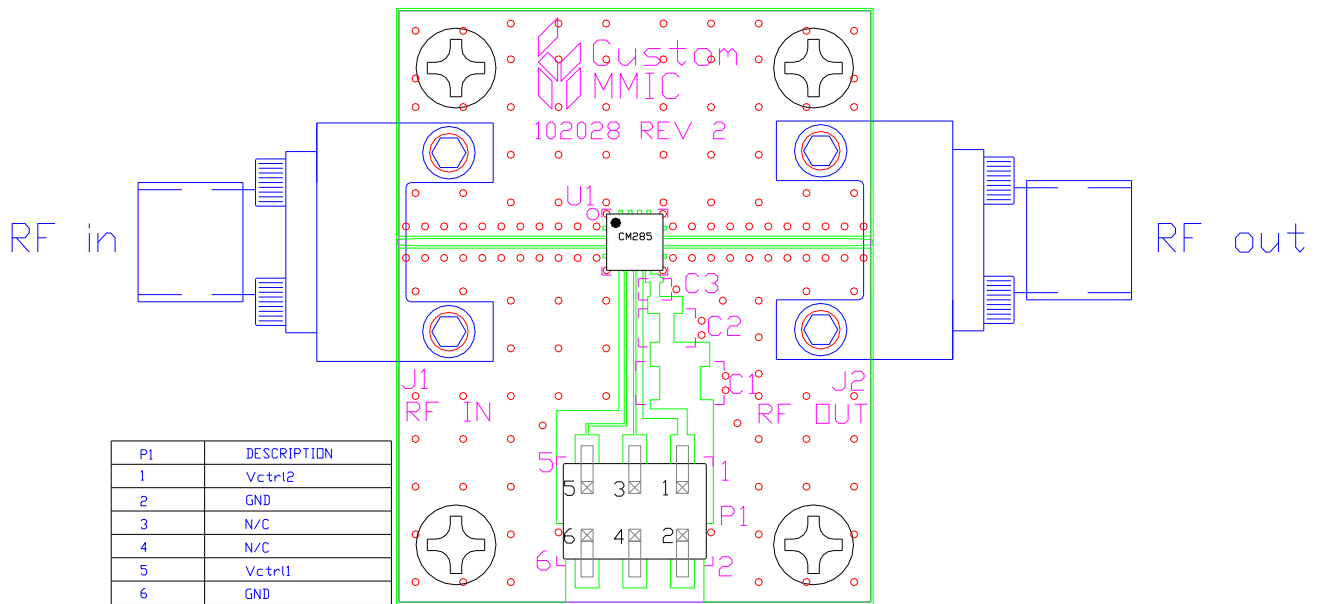

Designator	Value	Description
J1, J2		2.92 mm End Launch Connector
P1		6 Pin Header
U1		CMD285C3 VVA
PCB		102028 Evaluation PCB

GaAs MMIC devices are susceptible to damage from Electrostatic Discharge. Proper precautions should be observed during handling, assembly and test.

Handling Precautions

Parameter	Rating	Standard
ESD – Human Body Model (HBM)	Class 1A	ESDA / JEDEC JS-001-2012
MSL – Moisture Sensitivity Level	Level 1	JEDEC standard IPC/JEDEC J-STD-020



Caution!
ESD-Sensitive Device

RoHS Compliance

This part is compliant with 2011/65/EU RoHS directive (Restrictions on the Use of Certain Hazardous Substances in Electrical and Electronic Equipment) as amended by Directive 2015/863/EU.

This product also has the following attributes:

- Lead Free
- Antimony Free
- TBBP-A (C₁₅H₁₂Br₄O₂) Free
- SVHC Free
- Halogen Free
- PFOS Free

Contact Information

For the latest specifications, additional product information, worldwide sales and distribution locations:

Web: www.qorvo.com

Tel: 1-844-890-8163

Email: customer.support@qorvo.com

Important Notice

The information contained in this Data Sheet and any associated documents (“Data Sheet Information”) is believed to be reliable; however, Qorvo makes no warranties regarding the Data Sheet Information and assumes no responsibility or liability whatsoever for the use of said information. All Data Sheet Information is subject to change without notice. Customers should obtain and verify the latest relevant Data Sheet Information before placing orders for Qorvo® products. Data Sheet Information or the use thereof does not grant, explicitly, implicitly or otherwise any rights or licenses to any third party with respect to patents or any other intellectual property whether with regard to such Data Sheet Information itself or anything described by such information.

DATA SHEET INFORMATION DOES NOT CONSTITUTE A WARRANTY WITH RESPECT TO THE PRODUCTS DESCRIBED HEREIN, AND QORVO HEREBY DISCLAIMS ANY AND ALL WARRANTIES WITH RESPECT TO SUCH PRODUCTS WHETHER EXPRESS OR IMPLIED BY LAW, COURSE OF DEALING, COURSE OF PERFORMANCE, USAGE OF TRADE OR OTHERWISE, INCLUDING THE IMPLIED WARRANTIES OF MERCHANTABILITY AND FITNESS FOR A PARTICULAR PURPOSE. Without limiting the generality of the foregoing, Qorvo® products are not warranted or authorized for use as critical components in medical, life-saving, or life-sustaining applications, or other applications where a failure would reasonably be expected to cause severe personal injury or death. Applications described in the Data Sheet Information are for illustrative purposes only. Customers are responsible for validating that a particular product described in the Data Sheet Information is suitable for use in a particular application.

© 2023 Qorvo US, Inc. All rights reserved. This document is subject to copyright laws in various jurisdictions worldwide and may not be reproduced or distributed, in whole or in part, without the express written consent of Qorvo US, Inc. | QORVO® is a registered trademark of Qorvo US, Inc.