

QPA9442 - 860-960MHz Reference Design

Product Overview

The QPA9442 is a wideband, high linearity driver amplifier. With optimized tuning, this device can provide up to 19dB of gain and achieve an output P1dB of 1W. The amplifier can provide excellent linearity performance with +46dBm output 3rd order intercept (OIP3), making it perfectly suited for 5G base station applications.

The QPA9442 is tunable over all cellular bands in the entire operating frequency band of 0.6 – 5.0 GHz and incorporates a shut-down function through the V_{PD} pin.

The QPA9442 is housed in a 20-pin 4X4mm SMT package.

Referenced Documents

The reference documents below take precedence over the contents of this application note and should always be consulted for the latest information.

QPA9442 Data Sheet.

APPLICATION NOTE: QPA9442 - 860-960MHz Reference Design

Typical Performance, 860 – 960 MHz Reference Design

Parameter	Conditions	Typical Value			Units
Frequency		860	920	960	MHz
Gain		20.3	20.4	20.3	dB
Input Return Loss		14.1	22.6	17.9	dB
Output Return Loss		15.3	14.9	14.7	dB
Output P1dB		+29.6	+30.0	+29.6	dB
Output P3dB		+30.7	+30.9	+30.7	dBm
Output IP3	Pout = +18dBm/tone, $\Delta f = 1\text{MHz}$	+42.7	+42.7	+42.1	dBm
ACPR	Pout=+20 dBm, LTE 1C 20MHz, 8.5dB PAR	-51.2	-52.4	-51.6	dBc
Device Current	V_{CC} and V_{BIAS} combined	240			mA

Notes:

1. Test Conditions unless otherwise noted: $V_{CC} = V_{BIAS} = +5.0\text{V}$, $V_{PD} = +1.8\text{V}$, $I_{OQ} = 235\text{mA}$, Temp = +25 °C, 50 Ω system.

APPLICATION NOTE: QPA9442 - 860-960MHz Reference Design

Performance Plots

Qorvo Field and Factory Applications Engineers are available to provide technical assistance for determining appropriate matching networks for a particular application.

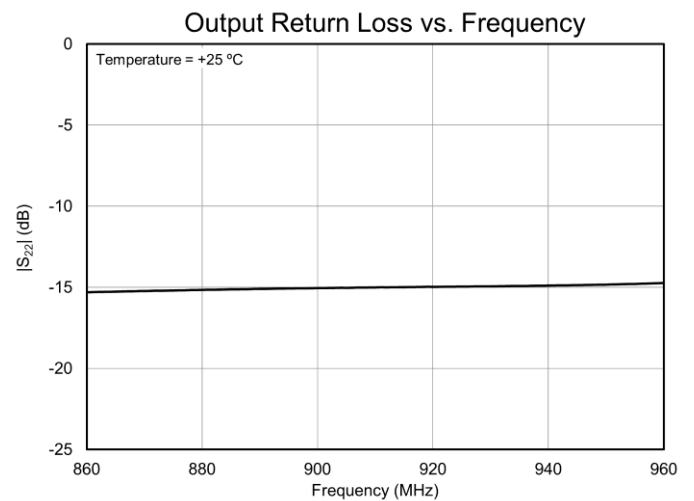
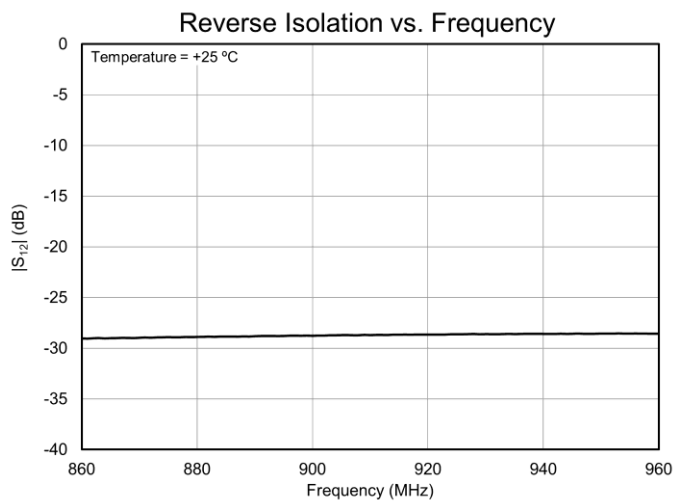
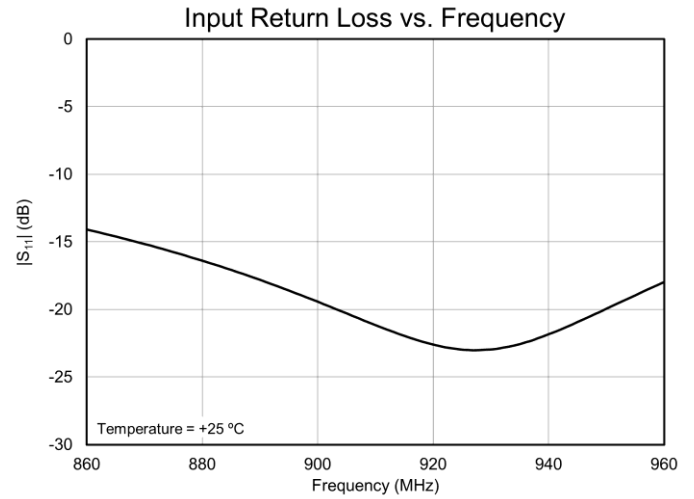
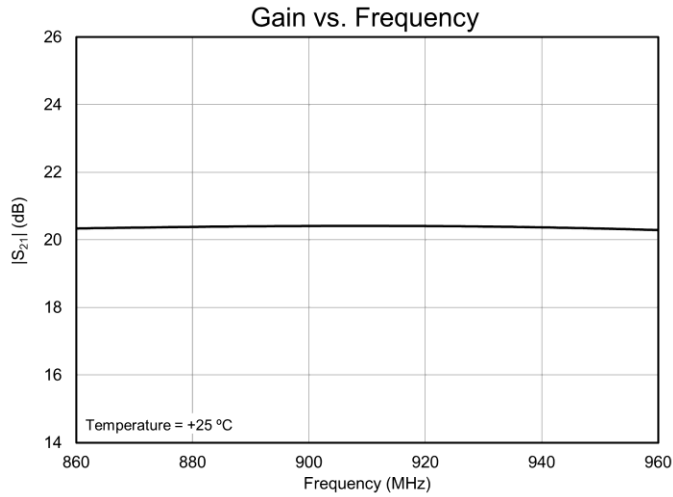

APPLICATION NOTE: QPA9442 - 860-960MHz Reference Design

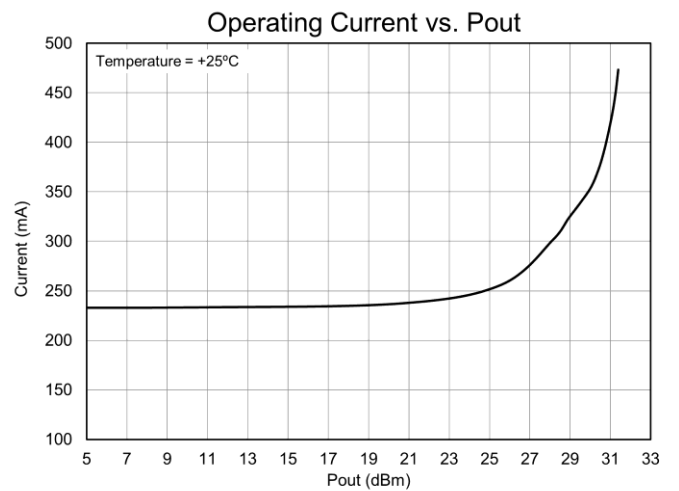
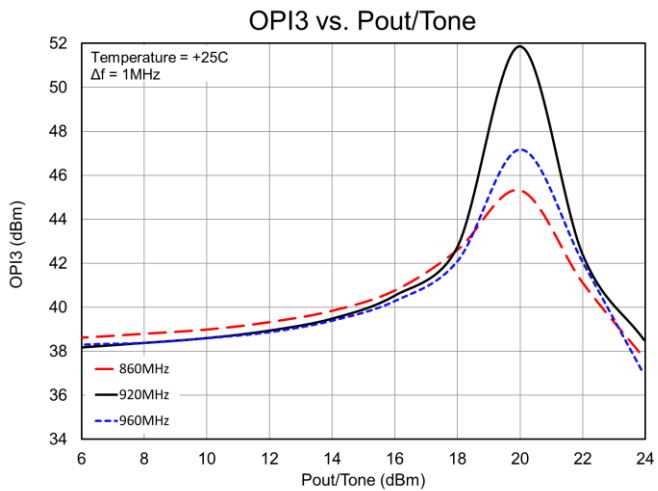
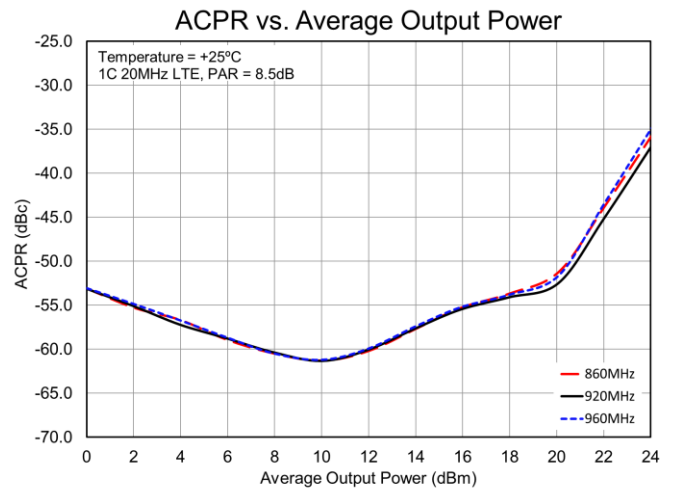
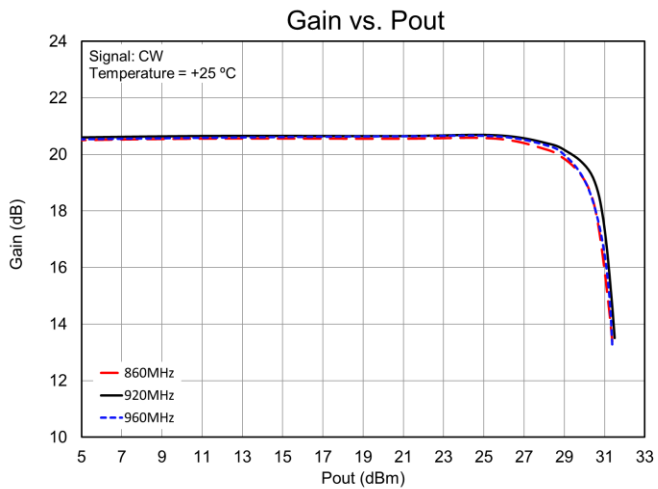
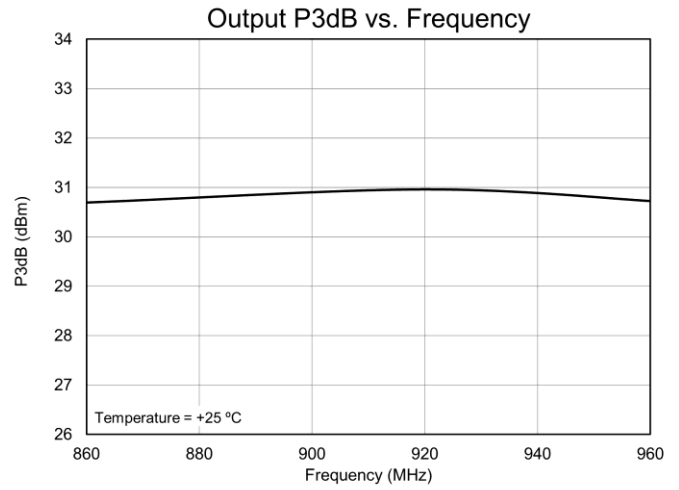
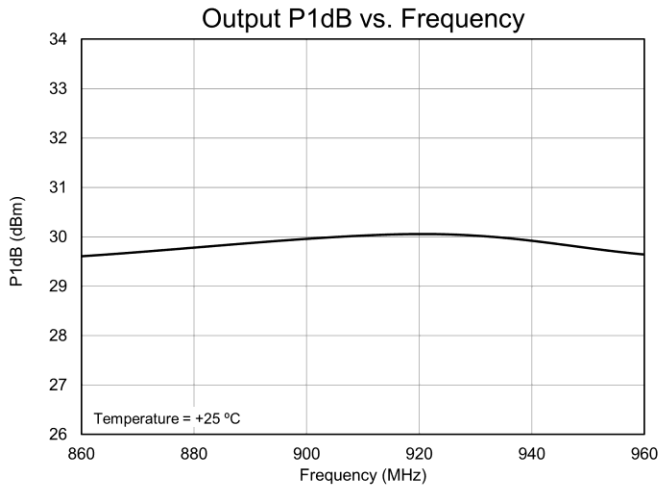

APPLICATION NOTE: QPA9442 - 860-960MHz Reference Design

Evaluation Board Information

Evaluation Board (EVB) Layout Assembly and Schematic

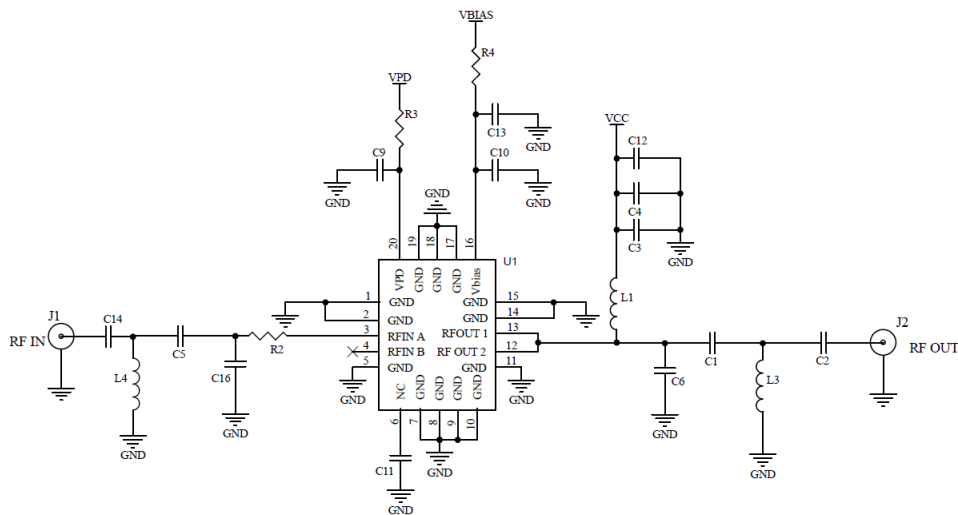
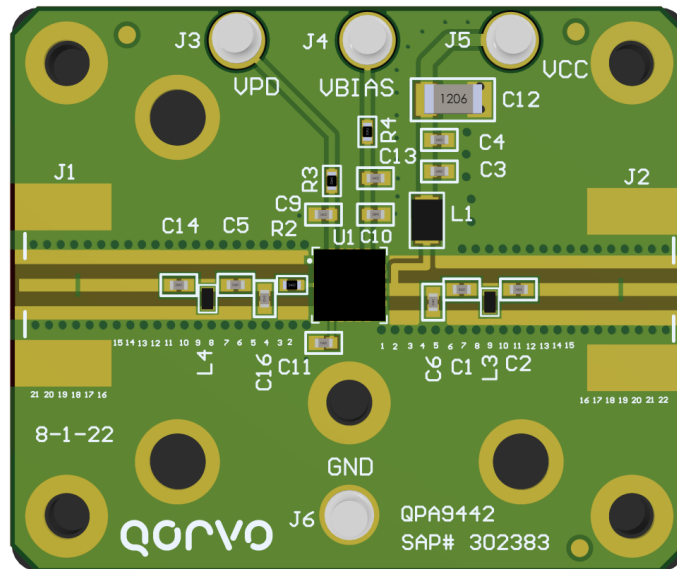

Notes:

1. Components shown on the PCB layout but not on the schematic are not used.

APPLICATION NOTE: QPA9442 - 860-960MHz Reference Design

Evaluation Board Bill of Material

Reference Des.	Value	Description	Manuf.	Part Number
n/a	n/a	Printed Circuit Board	Qorvo	
U1	n/a	1 W High Linearity Amplifier	Qorvo	QPA9442
C1	3.3 nH	IND, 0402, ± 0.1 nH, W/W	Various	
C2, C14	22 pF	CAP, 0402, 5%, 50V, HI-Q	Various	
C3, C9, C10	220 pF	CAP, 0402, 5%, 50V, C0G	Various	
C6	1.2 pF	CAP, 0402, 5%, 50V, HI-Q	Various	
C11	DNP	n/a	n/a	
C4, C13	1 uF	CAP, 0402, 10%, 10V, X7S	Various	
C12	10 μ F	CAP, 1206, 10%, 25V, X7R	Various	
C16	1 pF	CAP, 0402, 5%, 50V, HI-Q	Various	
L1	5.6 nH	IND, 0805, 2%, W/W	Murata	
L3	4.2 pF	CAP, 0402, ± 0.1 pF, 50V, HI-Q	Murata	
L4	6.8 pF	CAP, 0402, ± 0.1 pF, 50V, HI-Q	Murata	
R2	2.2 Ω	RES, 0402, 5%, 1/16W	Various	
C5, R3, R4	0 Ω	RES, 0402, 1/10W	Various	

APPLICATION NOTE: QPA9442 - 860-960MHz Reference Design

Additional Information

For information on ESD, Soldering Profiles, Packaging Standards, Handling and Assembly, please contact Qorvo for general guidelines.

Contact Information

For the latest specifications, additional product information, worldwide sales and distribution locations:

Web: www.qorvo.com

Tel: 1-844-890-8163

Email: customer.support@qorvo.com

Important Notice

The information contained in this Data Sheet and any associated documents ("Data Sheet Information") is believed to be reliable; however, Qorvo makes no warranties regarding the Data Sheet Information and assumes no responsibility or liability whatsoever for the use of said information. All Data Sheet Information is subject to change without notice. Customers should obtain and verify the latest relevant Data Sheet Information before placing orders for Qorvo® products. Data Sheet Information or the use thereof does not grant, explicitly, implicitly or otherwise any rights or licenses to any third party with respect to patents or any other intellectual property whether with regard to such Data Sheet Information itself or anything described by such information.

DATA SHEET INFORMATION DOES NOT CONSTITUTE A WARRANTY WITH RESPECT TO THE PRODUCTS DESCRIBED HEREIN, AND QORVO HEREBY DISCLAIMS ANY AND ALL WARRANTIES WITH RESPECT TO SUCH PRODUCTS WHETHER EXPRESS OR IMPLIED BY LAW, COURSE OF DEALING, COURSE OF PERFORMANCE, USAGE OF TRADE OR OTHERWISE, INCLUDING THE IMPLIED WARRANTIES OF MERCHANTABILITY AND FITNESS FOR A PARTICULAR PURPOSE. Without limiting the generality of the foregoing, Qorvo® products are not warranted or authorized for use as critical components in medical, life-saving, or life-sustaining applications, or other applications where a failure would reasonably be expected to cause severe personal injury or death. Applications described in the Data Sheet Information are for illustrative purposes only. Customers are responsible for validating that a particular product described in the Data Sheet Information is suitable for use in a particular application.

© 2025 Qorvo US, Inc. All rights reserved. This document is subject to copyright laws in various jurisdictions worldwide and may not be reproduced or distributed, in whole or in part, without the express written consent of Qorvo US, Inc. | QORVO® is a registered trademark of Qorvo US, Inc.