

### Product Overview

Qorvo’s QPC2320 is an ultra-wide band SOI Single-Pole, Double-Throw (SPDT) reflective switch.

Operating from 0.02 to 20GHz, the QPC2320 typically supports up to 1W input power handling at control voltages of 0/+3 V. This switch maintains low insertion loss of 1 dB or less and greater than 40 dB isolation at 20 GHz, making it ideal for high isolation switching applications across both defense and commercial platforms.

The QPC2320 is offered in a 2.25 x 2.25 mm with Flip-Chip on laminate-based package. This, along with the minimal DC power consumption, allows for easy system integration.

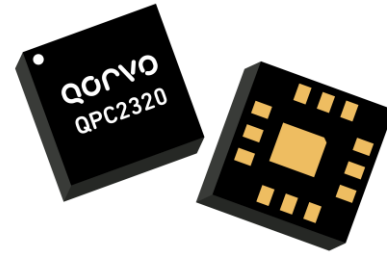

12 Pad 2.25 x 2.25 mm QFN Package

### Key Features

- Frequency Range: 0.02 – 20 GHz
- Insertion Loss: < 1 dB
- Power Handling: ≤1W
- Isolation: > 40 dB
- Return Loss: > 15 dB
- Control Voltages: +0/3 V
- Switching Time: < 50 ns
- RF Settling Time: < 66 ns
- Reflective Switch
- Package Dimensions: 2.25 x 2.25 x 0.92 mm

*Performance is typical across frequency. Please reference the electrical specification table and data plots for more details.*

### Functional Block Diagram

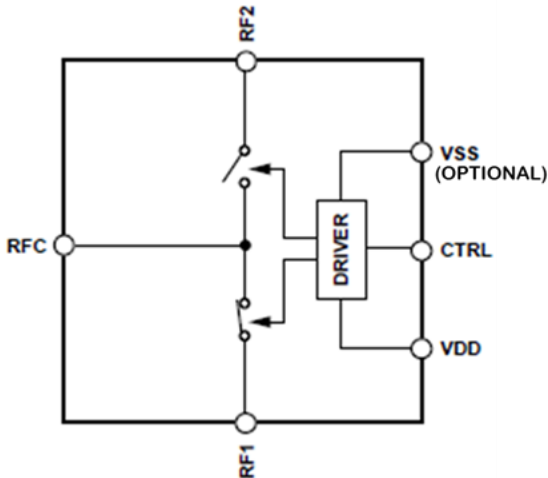

Top View

### Applications

- Test & Measurement
- EW

### Ordering Information

Part No.	Description
QPC2320TR7	0.02 – 20 GHz SOI SPDT Switch 500 Piece 7" Reel
QPC2320SR	100 Piece 7" Reel
QPC2320EVB	QPC2320 Evaluation Board

### Absolute Maximum Ratings

Parameter	Value
Supply Voltage ( $V_{DD}$ )	-0.5V to +6V
Negative Supply Voltage ( $V_{SS}$ )	-6V to +0.5V
Control Voltage ( $V_{CTRL}$ )	-0.5V to +6V
Input Power, CW, 50 $\Omega$ , 85°C	34 dBm
Input Power, CW, 50 $\Omega$ , 105°C	33 dBm
Input Power, Hot Switching, 50 $\Omega$ , 85°C	30 dBm
Input Power, Hot Switching, 50 $\Omega$ , 105°C	29 dBm
Channel Temperature: $T_j$ for $\geq 10^6$ hours MTTF	125 °C
Mounting Temperature (30 Seconds)	260 °C
Storage Temperature	-65 to 150 °C

Operation of this device outside the parameter ranges given above may cause permanent damage. These are stress ratings only, and functional operation of the device at these conditions is not implied.

### Recommended Operating Conditions

Parameter	Min	Typ.	Max	Units
Frequency	0.02	-	20	GHz
Temperature Range	-40	+25	+105	°C
RF Power, CW, 105°C	-	-	30	dBm
RF Power, CW, Hot Switching, 105°C	-	-	29	dBm
Control Voltage High ( $V_{CTRL}$ )	1.17	3	$V_{DD}$	V
Control Voltage Low ( $V_{CTRL}$ )	-0.3	0	0.63	V
Control Current ( $V_{CTRL}$ )	-20	-	+20	$\mu A$
Supply Voltage ( $V_{DD}$ )	3.15	3.3	5.5	V
Supply Current ( $I_{DD}$ )	-	100	-	$\mu A$
Negative Supply Voltage ( $V_{SS}$ ) <sup>(1)</sup>	-5.5	-3.3	-3	V
Negative Supply Current ( $I_{SS}$ )	-	-100	-	$\mu A$

Electrical specifications are measured at specified test conditions. Specifications are not guaranteed over all recommended operating conditions.

<sup>(1)</sup> if this pin is grounded, there is no need to supply negative voltage since internal negative voltage generator is activated. But there will be low level (<-120dBm) spurs around 1MHz due to oscillator.

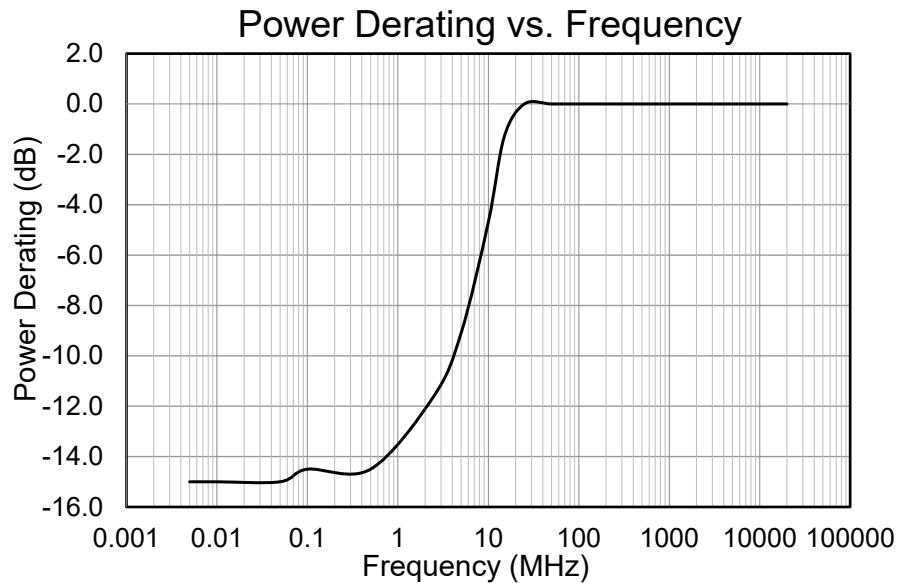

## Electrical Specifications

Test conditions unless otherwise noted: 50  $\Omega$ , 25 °C,  $V_{CTRL} = +0/3$  V,  $V_{DD} = +3.3$ V, see function table on page 11.

Parameter	Min	Typ.	Max	Units	
Operational Frequency Range	0.02	-	20	GHz	
Insertion Loss (On-State)	Frequency = 0.02 GHz	-	0.43	-	dB
	Frequency = 0.10 GHz	-	0.44	-	
	Frequency = 1 GHz	-	0.46	-	
	Frequency = 10 GHz	-	0.78	-	
	Frequency = 20 GHz	-	0.86	-	
Input Return Loss (On-State) Common Port RL	Frequency = 0.02 GHz	-	29.3	-	dB
	Frequency = 0.10 GHz	-	28.3	-	
	Frequency = 1 GHz	-	29.6	-	
	Frequency = 10 GHz	-	16.4	-	
	Frequency = 20 GHz	-	27.9	-	
Output Return Loss (On-State) Switched Port RL	Frequency = 0.02 GHz	-	29.5	-	dB
	Frequency = 0.10 GHz	-	28.0	-	
	Frequency = 1 GHz	-	29.4	-	
	Frequency = 10 GHz	-	15.4	-	
	Frequency = 20 GHz	-	20.2	-	
Isolation (Off-State) (RFC – RFX)	Frequency = 0.02 GHz	-	83.0	-	dB
	Frequency = 0.10 GHz	-	83.0	-	
	Frequency = 1 GHz	-	63.4	-	
	Frequency = 10 GHz	-	46.0	-	
	Frequency = 20 GHz	-	44.7	-	

## Electrical Specifications (Cont.)

Test conditions unless otherwise noted: 50  $\Omega$ , 25 °C,  $V_{CTRL} = +0/3$  V,  $V_{DD} = +3.3$ V, see function table on page 11.

Parameter	Min	Typ.	Max	Units	
Operational Frequency Range	0.02	-	20	GHz	
Isolation (Off-State) (RFX – RFX)	Frequency = 0.02 GHz	-	85.0	-	dB
	Frequency = 0.10 GHz	-	86.0	-	
	Frequency = 1 GHz	-	78.1	-	
	Frequency = 10 GHz	-	55.3	-	
	Frequency = 20 GHz	-	46.4	-	
Input Power ( $P_{1dB}$ )	Frequency = 0.02 – 20 GHz	-	33	-	dBm
Input IP3 $P_{IN} = 15$ dBm per tone, 1MHz tone spacing	Frequency = 0.02 GHz	-	54.3	-	dBm
	Frequency = 2.6 GHz	-	58.6	-	
	Frequency = 4 - 20 GHz	-	53 <sup>(2)</sup>	-	
2 <sup>nd</sup> Harmonic ( $P_{IN} = 15$ dBm)	Fo @ 1GHz	-	-80.3	-	dBm
	Fo @ 5GHz	-	-72.3	-	
3 <sup>rd</sup> Harmonic ( $P_{IN} = 15$ dBm)	Fo @ 1GHz	-	-79.9	-	dBm
	Fo @ 5GHz	-	-83.4	-	
Power-ON Time (Turn On time) 90% $V_{DD}$ to Harmonics settled, $V_{SS} = 0$ V	-	220	-	ns	
Switch Time (On and OFF time)	50% control to 10/90% RF	-	47	-	ns
Switch Time (RF Settling 0.05 dB)	50% control to 0.05dB from final RF output	-	65	-	ns
Control Voltage ( $V_{CTRL}$ )	-	3	$V_{DD}$	V	
Thermal Resistance ( $\theta_{JC}$ ) <sup>(1)</sup> , $T_{BASE} = 105$ °C	-	140	-	C °/W	

**Notes:**

1. Measured to the back of the package.
2. Reference to note on plot of IIP3 vs Frequency on page 10

**Performance Plots – Small Signal**

Test conditions unless otherwise noted: RFC = Port 1; RF1 = Port 2; RF2 = Port 3;  $V_{CTRL} = +0/3\text{ V}$ ,  $V_{DD} = +3.3\text{ V}$ ,  $V_{SS} = 0\text{ V}$ ,  $50\ \Omega$

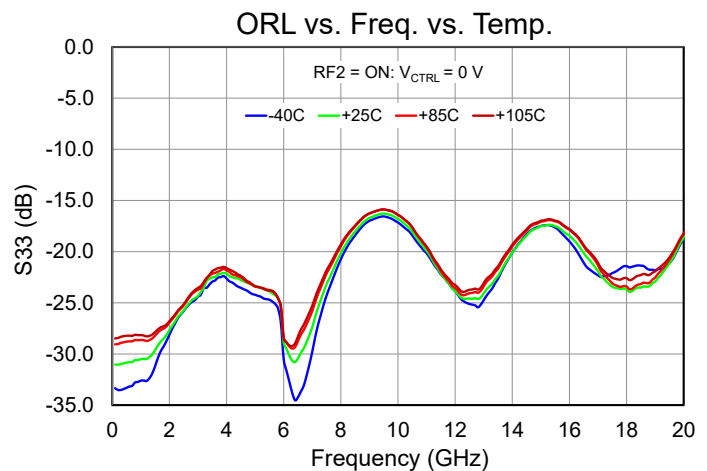
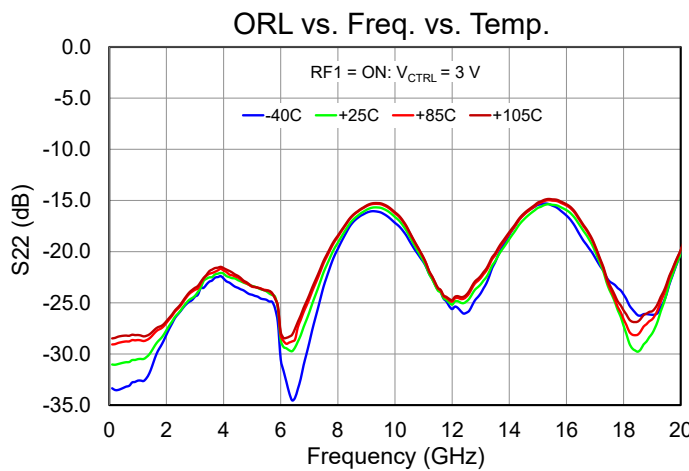
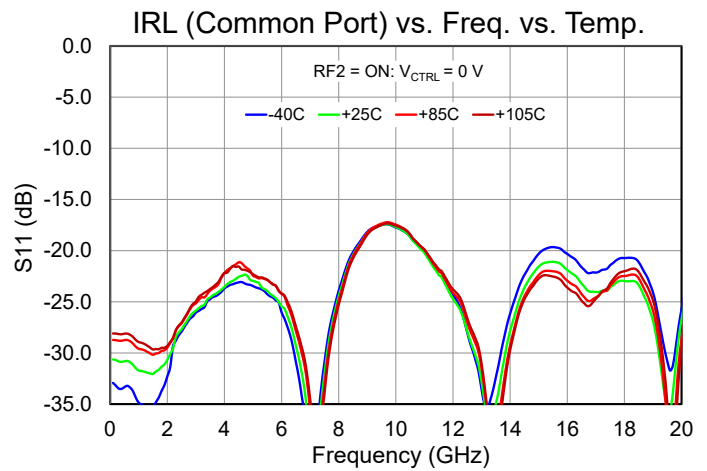
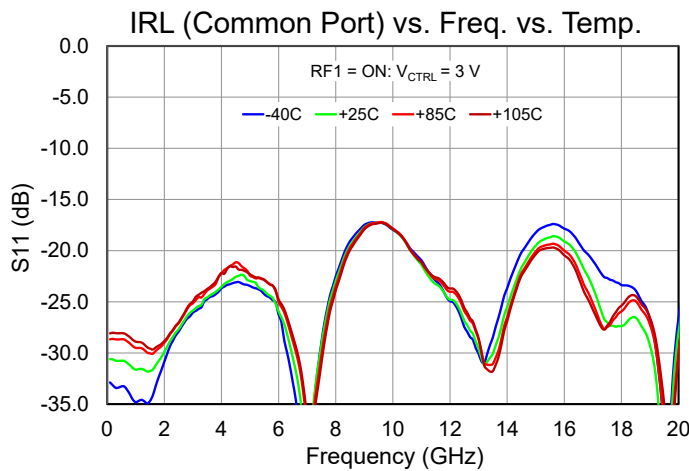
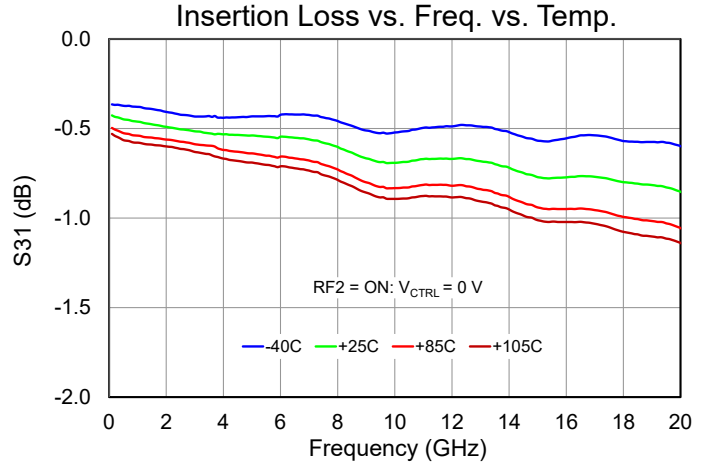
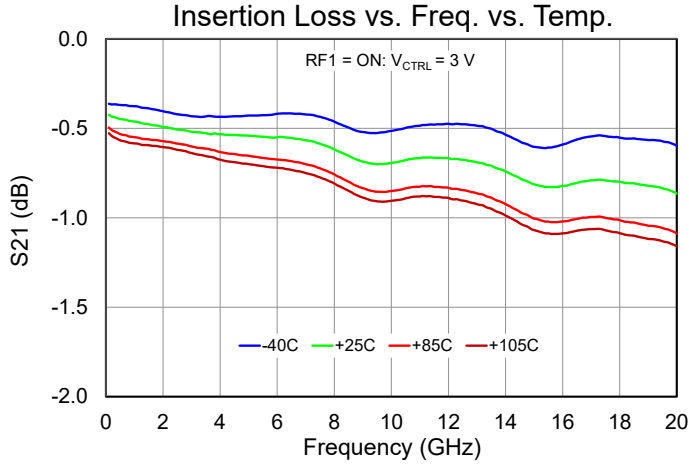

Performance Plots – Small Signal - Continued

Test conditions unless otherwise noted: RFC = Port 1; RF1 = Port 2; RF2 = Port 3;  $V_{CTRL} = +0/3\text{ V}$ ,  $V_{DD} = +3.3\text{ V}$ ,  $V_{SS} = 0\text{ V}$ ,  $50\ \Omega$

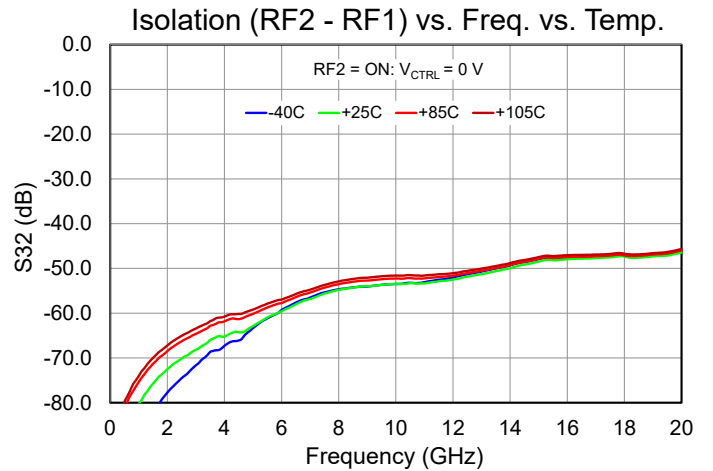
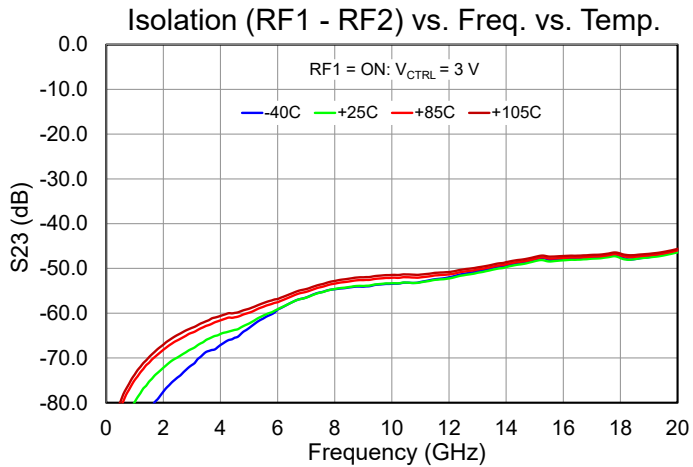
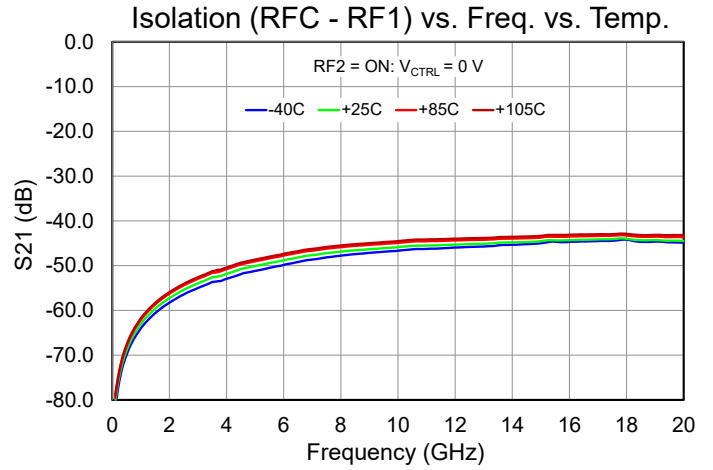
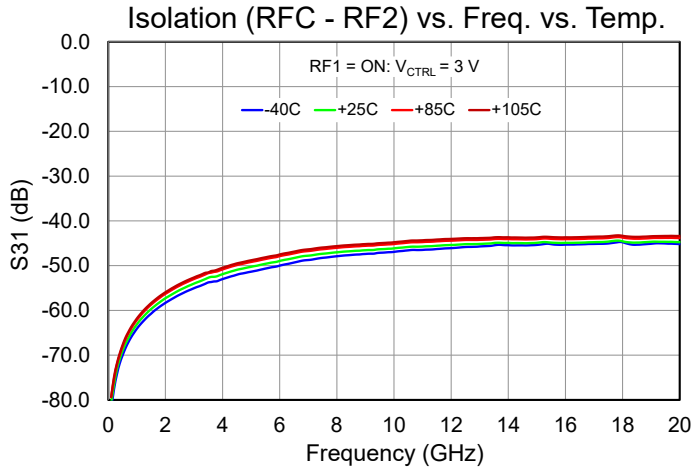

Performance Plots – Small Signal - Continued

Test conditions unless otherwise noted: RFC = Port 1; RF1 = Port 2; RF2 = Port 3; Temp= +25 °C, V<sub>CTRL</sub> = +0/3 V, V<sub>SS</sub> = 0 V, 50 Ω

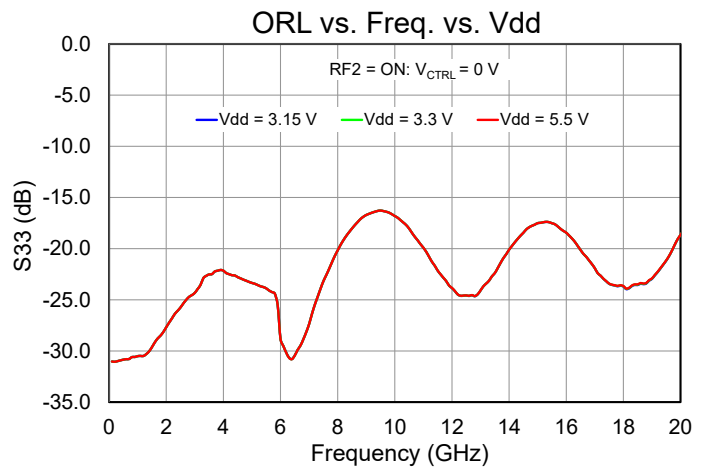
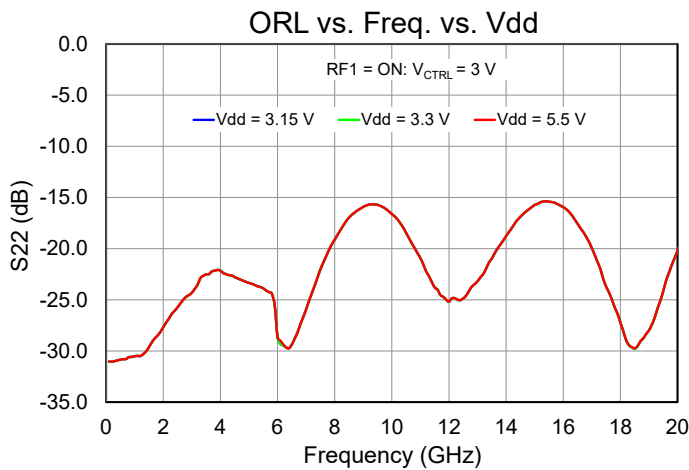
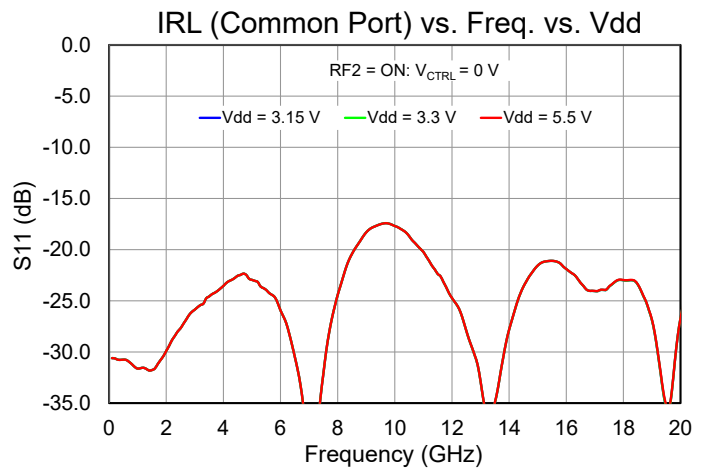
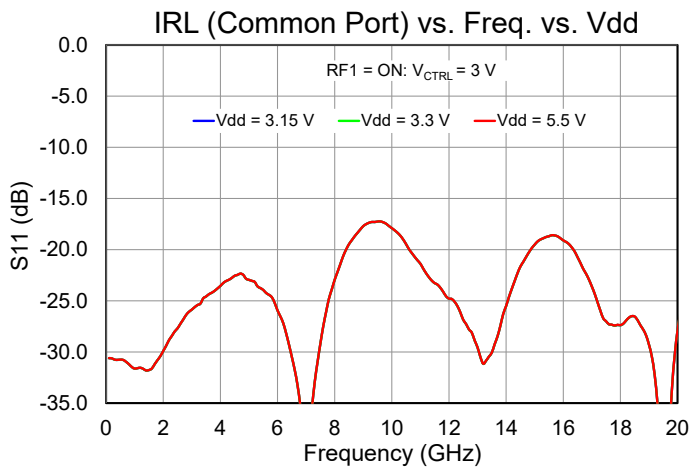
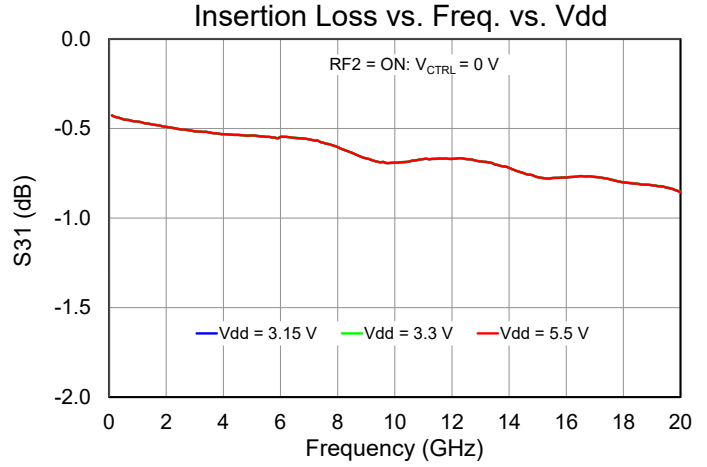
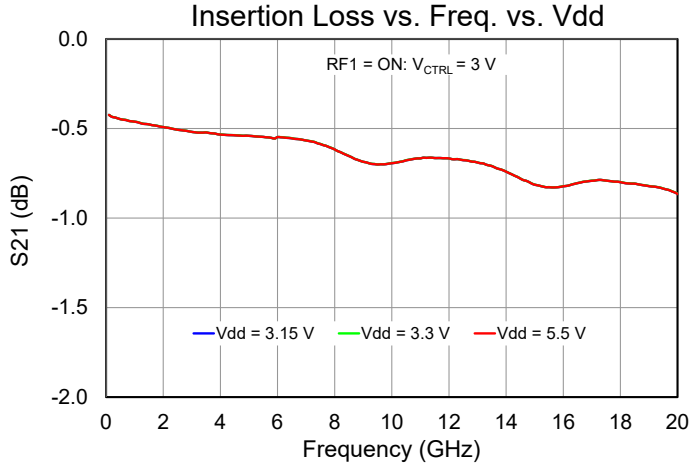

Performance Plots – Small Signal - Continued

Test conditions unless otherwise noted: RFC = Port 1; RF1 = Port 2; RF2 = Port 3; Temp= +25 °C, V<sub>CTRL</sub> = +0/3 V, V<sub>DD</sub> = +3.3 V, 50 Ω

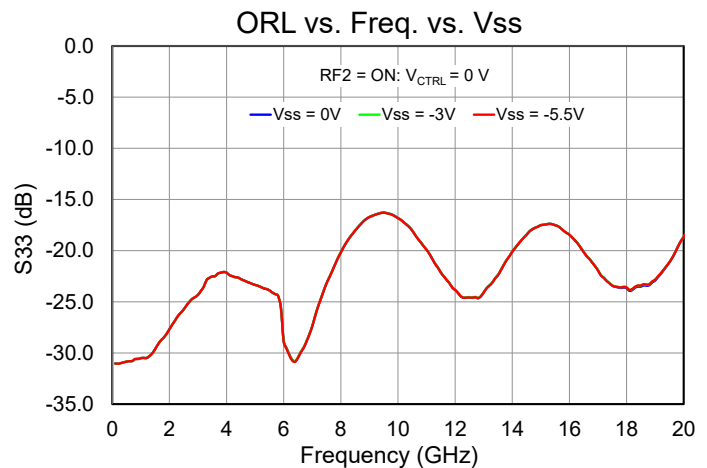
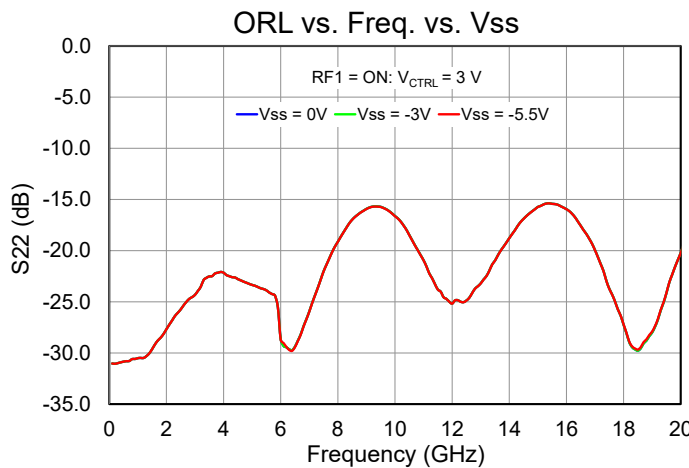
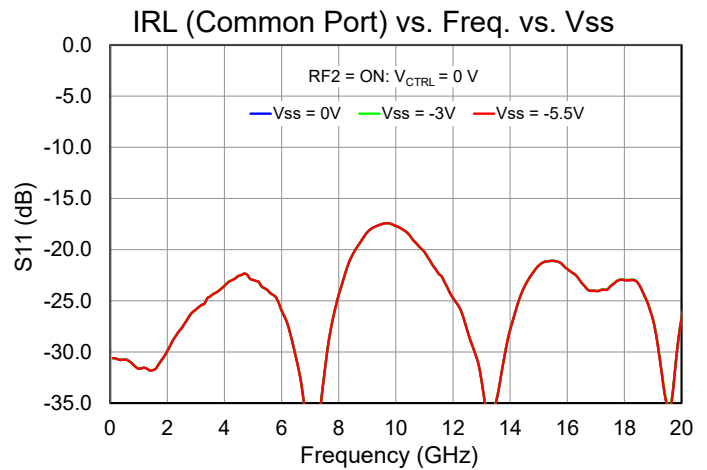
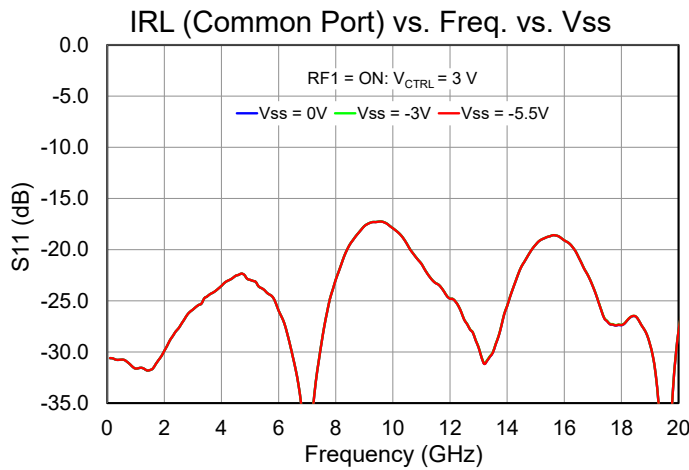
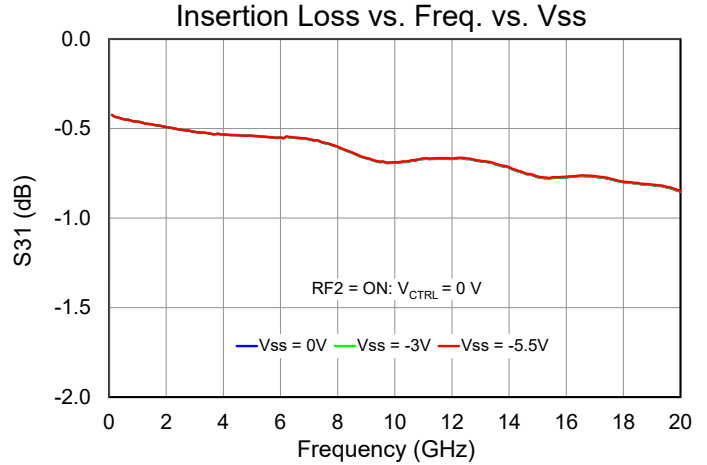
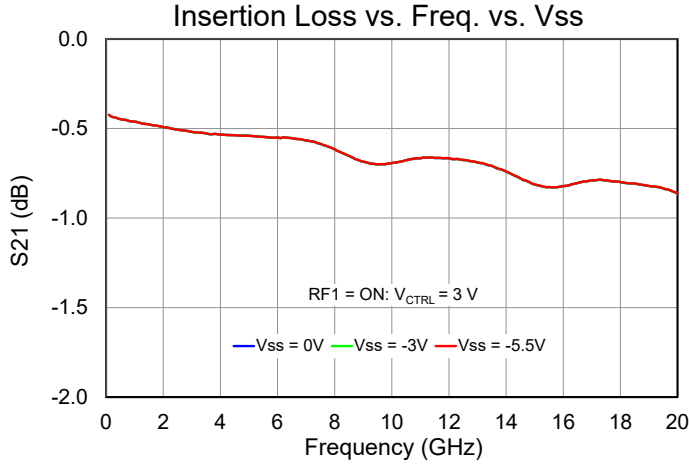

Performance Plots – Small Signal - Continued

Test conditions unless otherwise noted: RFC = Port 1; RF1 = Port 2; RF2 = Port 3; Temp= +25 °C, V<sub>CTRL</sub> = +0/3 V, V<sub>DD</sub> = +3.3 V, 50 Ω

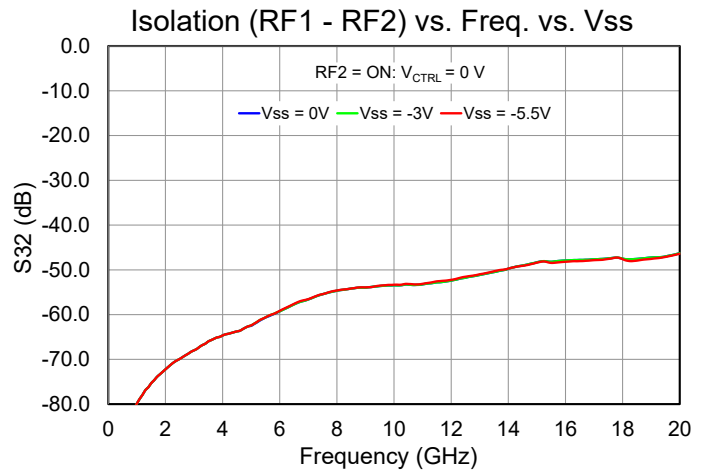
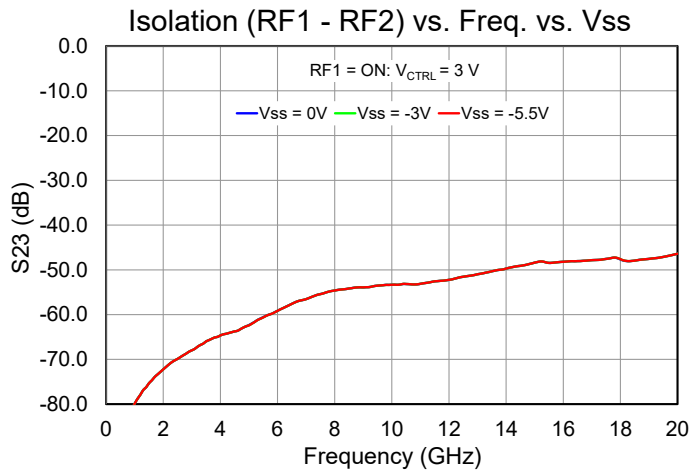
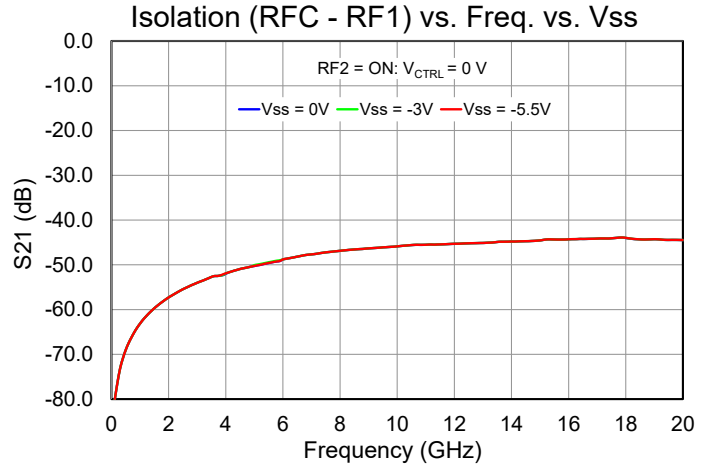
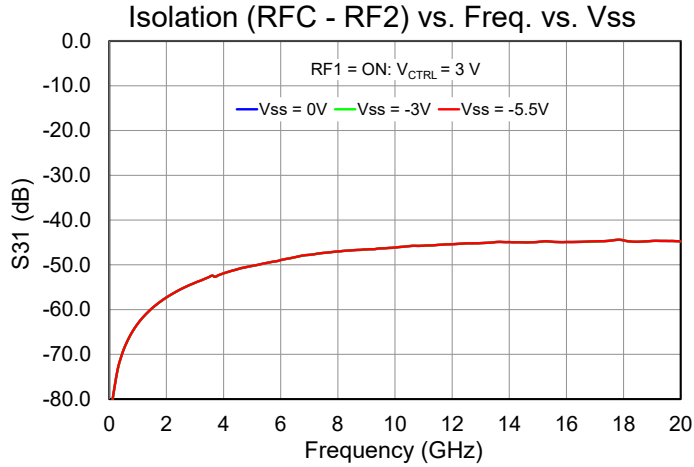

Performance Plots – Large Signal & Linearity

Test conditions unless otherwise noted: Temp= +25 °C, V<sub>DD</sub> = +3.3 V, V<sub>CTRL</sub> = +0/3 V, V<sub>SS</sub> = 0 V, 50 Ω System

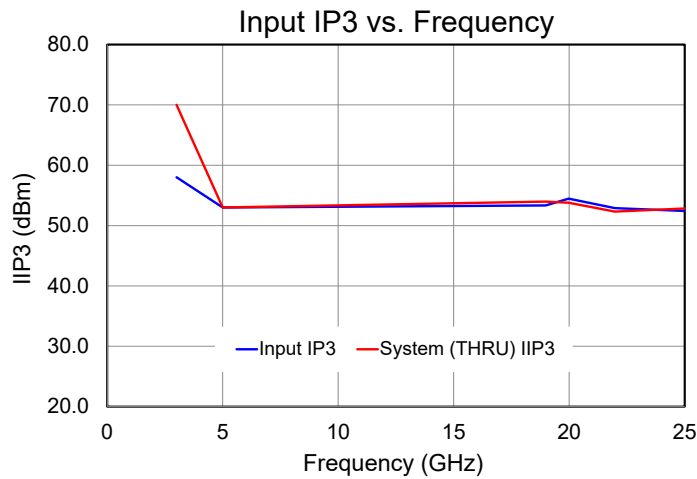
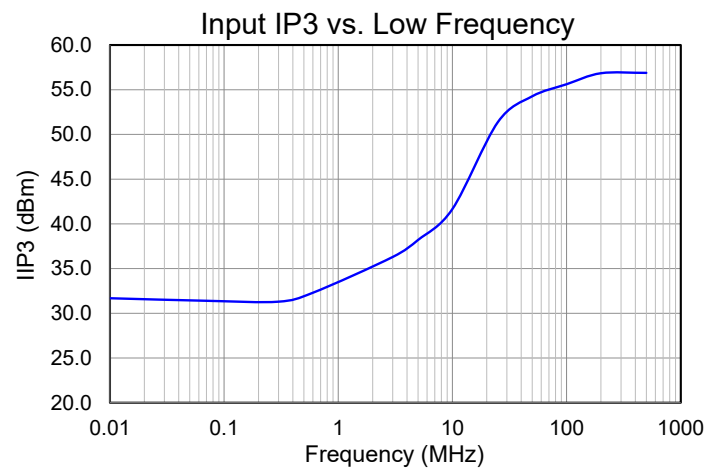
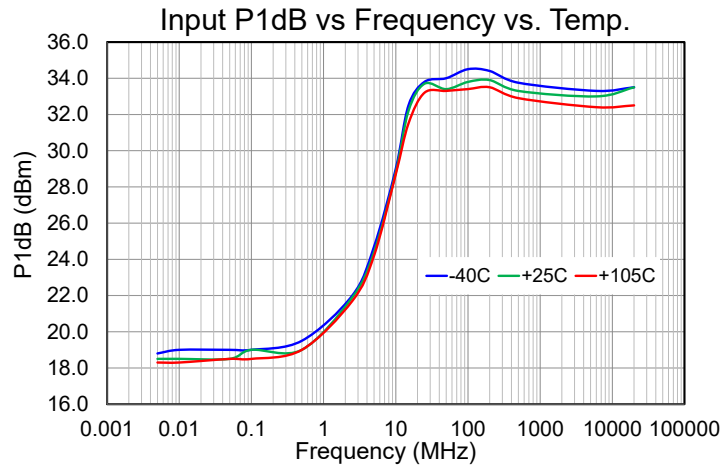

Higher frequencies TOI measurement is limited by test system. The system (THRU) data as shown in the graph is the TOI measurement without a DUT.

## Application Circuit

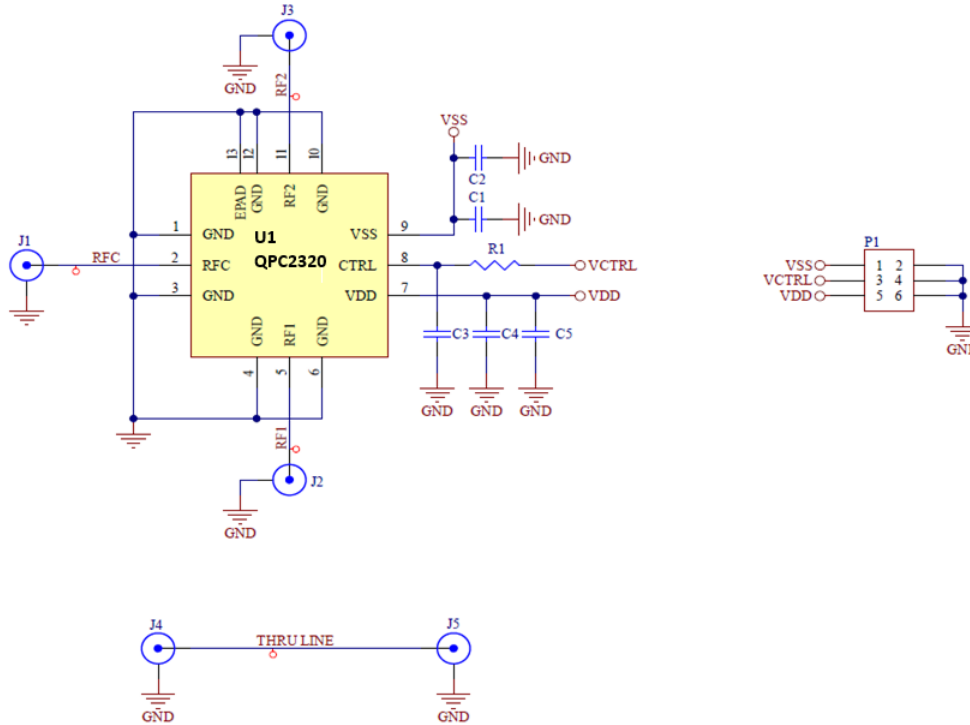

Notes:

1. This switch can be configured as a Single Pole, Single Throw (SPST) by terminating one unused RF switched port with a 50 Ohm load.

## Bill of Materials for EVB – QPC2320

Reference Des.	Value	Description	Manuf.	Part Number
R1 (Jumper)	0 KΩ	RES, 1/10 W, 0402	Various	–
C1, C3, C4	N/A	Not Populated	Various	-
C2, C5	100 pF	CAP, 5%, 50V, COG, 0402	Various	-
J1 to J5	N/A	2.4 mm end launch connectors	SW Microwave	1492-04A-12

## Switch Control Logic Truth Table

RF Path	State	V <sub>CTRL</sub>
RFC to RF1 (50 Ω load to RF2)	On-State (Insertion Loss)	High
	Off-State (Isolation)	Low
RFC to RF2 (50 Ω load to RF1)	On-State (Insertion Loss)	Low
	Off-State (Isolation)	High

V<sub>CTRL</sub> Logic: Low = 0 V, High = +3 V

**Evaluation Board (EVB) Layout**

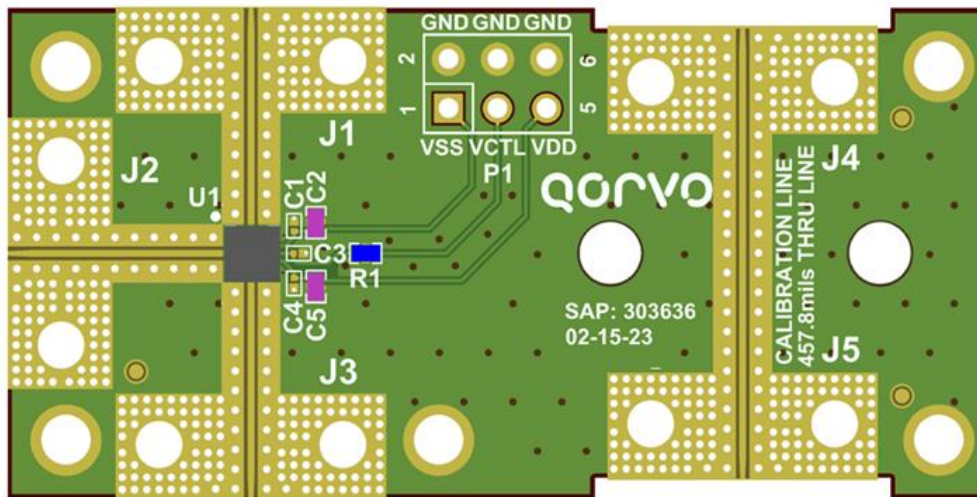
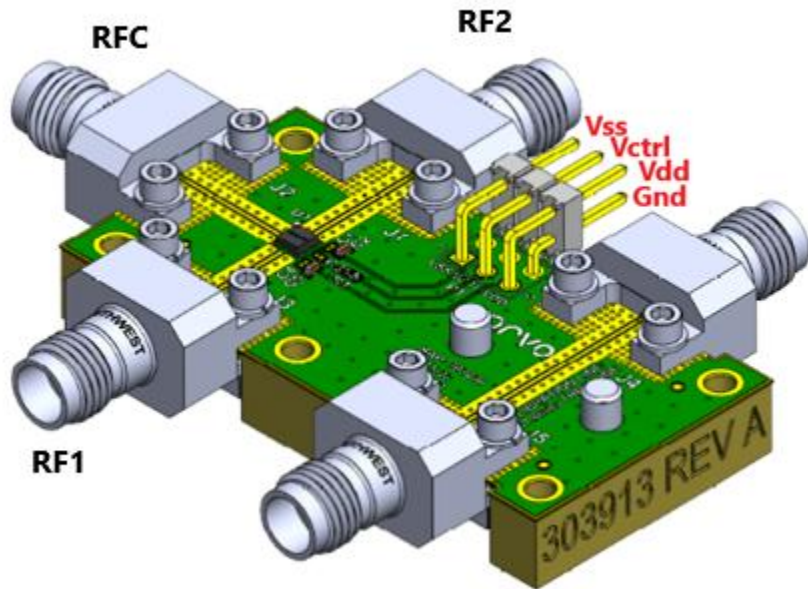

EVB Layout Details

Notes:

1. No DC blocking capacitor is necessary when the RF line potential is equal to 0V dc.
2. This switch can be configured as a Single Pole, Single Throw (SPST) by terminating one unused RF switched port with a 50 Ohm load.

Evaluation Board (EVB) Layout - Continue

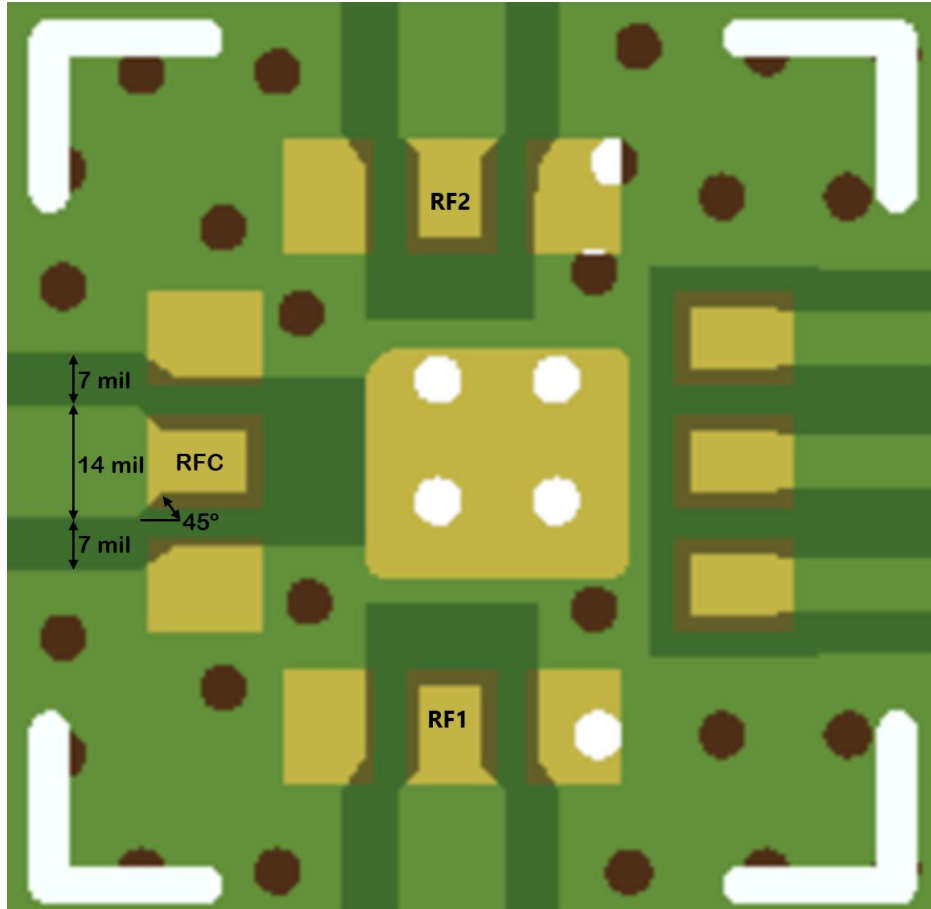

Landing Pattern

- Notes:
1. The RF transmission 50 Ω line width for RFC, RF1 & RF2 is 14 mil and the gap for ground clearance is 7 mil.
  2. The pad pattern shown has been developed and tested for optimized assembly at Qorvo Inc. The PCB land pattern has been developed to accommodate lead and package tolerances. Since surface mount processes vary from company to company, careful process development is recommended.

Evaluation Board PCB Information

LAYER STACK LEGEND

Material	Layer	Thickness	Dielectric Material	Type	Comment
Surface Material	Top Overlay			Legend	HIGH TEMPERATURE, NON-CONDUCTIVE, WHITE EPOXY BASED INK.
Top Solder	Top Solder	0.0004	Solder Resist	Solder Mask	LPI (LIQUID PHOTO-IMAGEABLE) OR LDI (LASER DIRECT IMAGEABLE), GREEN.
Copper	Top Layer	0.0018		Signal	FINISH THICKNESS=0.5oz COPPER CLADDING + SURFACE PLATING/VIA PLATING/FINISH
Core	Core	0.0080	Rogers 4003	Dielectric	
Copper	Bottom Layer	0.0018		Signal	FINISH THICKNESS=0.5oz COPPER CLADDING + SURFACE PLATING/VIA PLATING/FINISH
Finished board thickness: 0.0120					

## Pad Configuration, Description and Marking

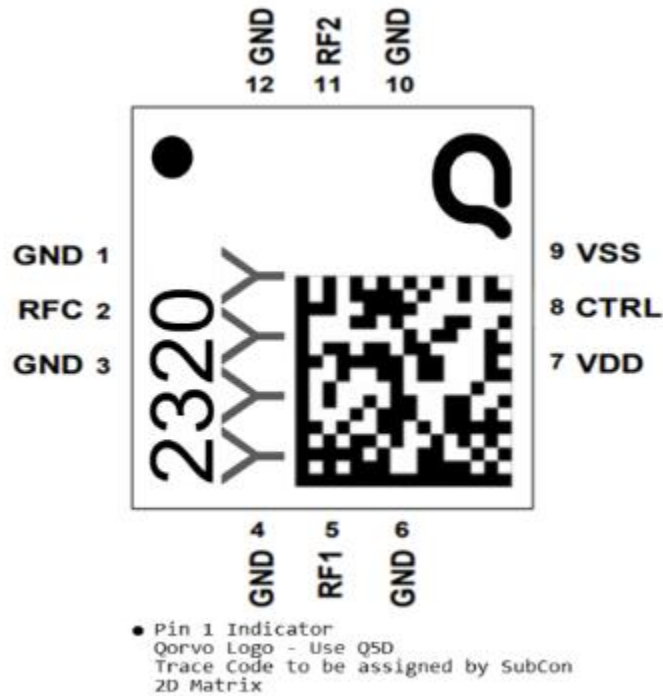

Pad No.	Label	Description
1,3,4,6,10,12	GND	Ground. Connected to ground paddle (13); must be grounded to PCB to improve isolation.
2	RFC	RF common port; matched to 50 Ω; DC coupled.
5	RF1	RF switched port 1; matched to 50 Ω; DC coupled.
7	VDD	Positive Supply Voltage.
8	CTRL	Control Input Voltage.
9	VSS	Negative Supply Voltage to disable internal NVG, or 0V to enable it.
11	RF2	RF switched port 2; matched to 50 Ω; DC coupled.
Package Base (13)	GND	Backside paddle. Multiple vias should be employed to minimize inductance and thermal resistance.

**Mechanical Information**

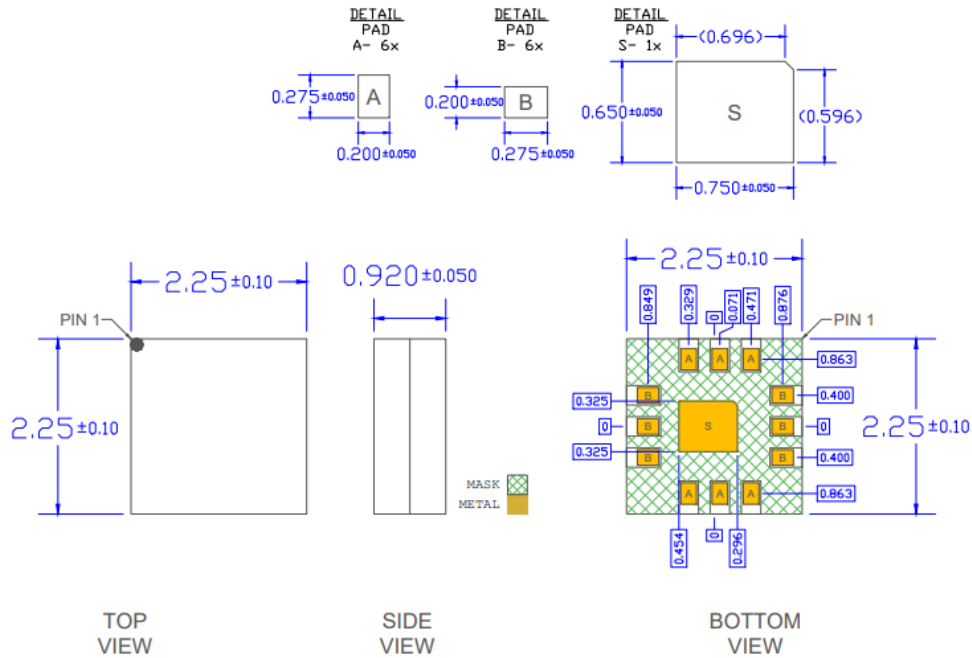

**PCB Mounting Pattern**

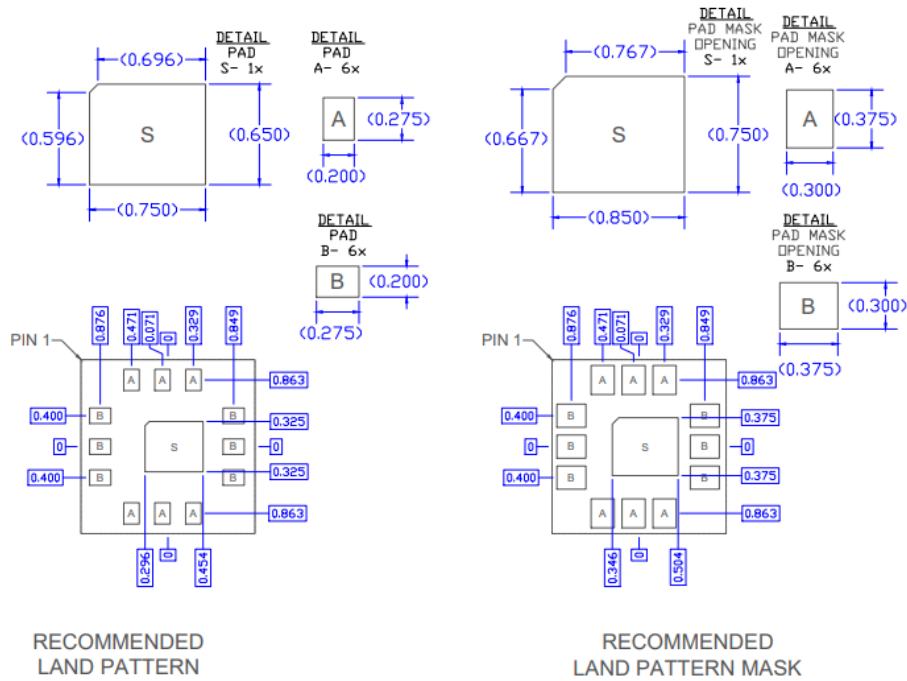

- Notes:
1. All dimensions are in millimeters. Angles are in degrees.
  2. This drawing specifies the mounting pattern used on the Qorvo evaluation board for this product. Some modification may be necessary to suit end user assembly materials and processes.

**Assembly Notes**

1. Compatible with the latest version of J-STD-020, lead-free solder, 260° C, and tin/lead (245°C max. reflow temp.) soldering processes.
2. Contact plating: Ni-Au

**Recommended Soldering Profile**

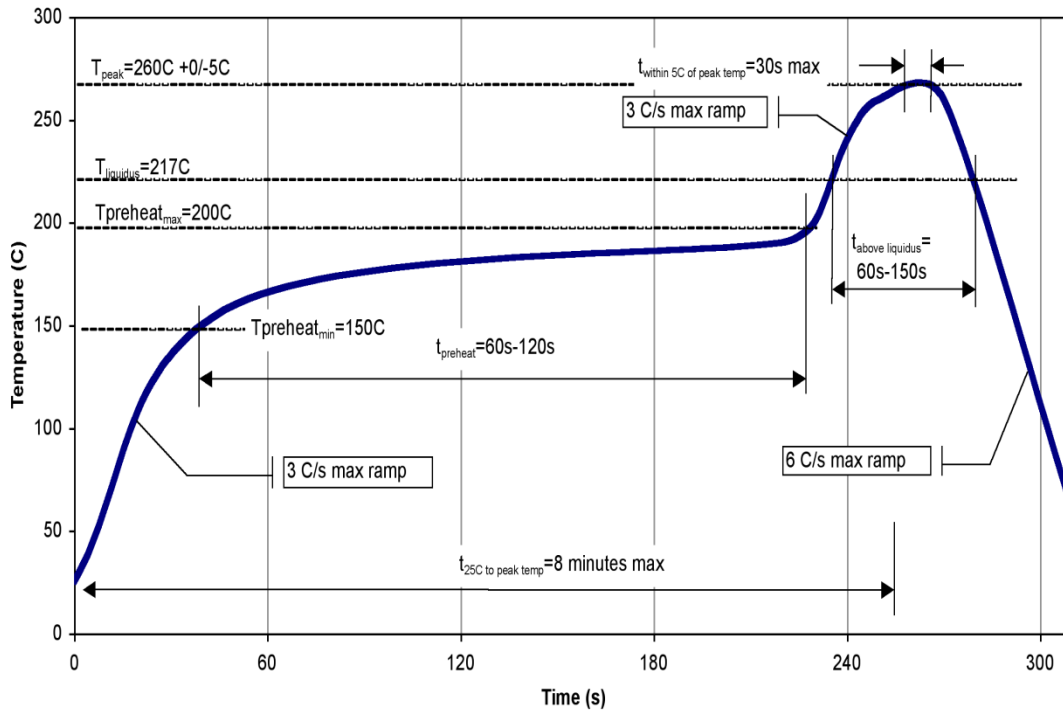

## Handling Precautions

Parameter	Rating	Standard
ESD – Human Body Model (HBM)	1C	ESDA / JEDEC JESD22-A114
ESD – Charged Device Model (CDM)	C3	JEDEC JESD22-C101
MSL – Moisture Sensitivity Level	Level 3	IPC/JEDEC J-STD-020



Caution!  
ESD-Sensitive Device

## RoHS Compliance

This part is compliant with 2011/65/EU RoHS directive (Restrictions on the Use of Certain Hazardous Substances in Electrical and Electronic Equipment) as amended by Directive 2015/863/EU.

This product also has the following attributes:

- Lead Free
- Halogen Free (Chlorine, Bromine)
- Antimony Free
- TBBP-A (C<sub>15</sub>H<sub>12</sub>Br<sub>4</sub>O<sub>2</sub>) Free
- PFOS Free
- SVHC Free

## Contact Information

For the latest specifications, additional product information, worldwide sales and distribution locations:

**Web:** [www.qorvo.com](http://www.qorvo.com)

**Tel:** 1-844-890-8163

**Email:** [customer.support@qorvo.com](mailto:customer.support@qorvo.com)

## Important Notice

The information contained herein is believed to be reliable; however, Qorvo makes no warranties regarding the information contained herein and assumes no responsibility or liability whatsoever for the use of the information contained herein. All information contained herein is subject to change without notice. Customers should obtain and verify the latest relevant information before placing orders for Qorvo products. The information contained herein or any use of such information does not grant, explicitly or implicitly, to any party any patent rights, licenses, or any other intellectual property rights, whether regarding such information or anything described by such information. **THIS INFORMATION DOES NOT CONSTITUTE A WARRANTY WITH RESPECT TO THE PRODUCTS DESCRIBED HEREIN, AND QORVO HEREBY DISCLAIMS ANY AND ALL WARRANTIES WITH RESPECT TO SUCH PRODUCTS WHETHER EXPRESS OR IMPLIED BY LAW, COURSE OF DEALING, COURSE OF PERFORMANCE, USAGE OF TRADE OR OTHERWISE, INCLUDING THE IMPLIED WARRANTIES OF MERCHANTABILITY AND FITNESS FOR A PARTICULAR PURPOSE.**

Without limiting the generality of the foregoing, Qorvo products are not warranted or authorized for use as critical components in medical, lifesaving, or life-sustaining applications, or other applications where a failure would reasonably be expected to cause severe personal injury or death.

Copyright 2026 © Qorvo, Inc. | Qorvo is a registered trademark of Qorvo, Inc.