

# QPA9903 – 1.616-1.626GHz Reference Design

## Product Overview

---

The QPA9903 is a high-efficiency, linearizable power amplifier targeting Band 3 small-cell wireless infrastructure systems. Using InGaP/GaAs HBT technology, the product delivers high efficiency of 33.8% at +28dBm average output power while providing excellent DPD linearized ACPR of -50dBc for signal bandwidths of up to 60MHz.

The QPA9903 is housed in a 5x5mm SMT package. It is pin-to-pin compatible to QPA9908 (band 8 high-efficiency small cell PA).

## Referenced Documents

The reference documents below take precedence over the contents of this application note and should always be consulted for the latest information.

QPA9903 Data Sheet.

## APPLICATION NOTE: QPA9903 – 1.616-1.626GHz Reference Design

## Application Electrical Performance

Qorvo Field and Factory Applications Engineers are available to provide technical assistance for determining appropriate matching networks for a particular application.

Parameter	Conditions	Typical Value			Units
Frequency		1616	1621	1626	MHz
Gain		30.9	31.0	31.1	dB
Input Return Loss		16.3	16.6	17.0	dB
Output Return Loss		12.2	12.1	12.1	dB
Output P1dB		29.8	-	29.5	dBm
Output P3dB		33.4	-	33.2	dBm
Device Current, I <sub>DD</sub>		103			mA

Test conditions unless otherwise noted: All V<sub>CC</sub> & V<sub>BIAS</sub> = +5.0V, V<sub>EN</sub> = +1.8V, Temp = +25 °C, 50 Ω system.

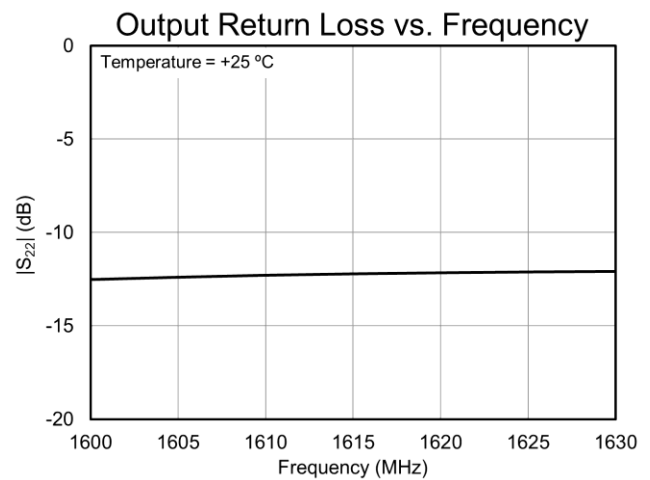
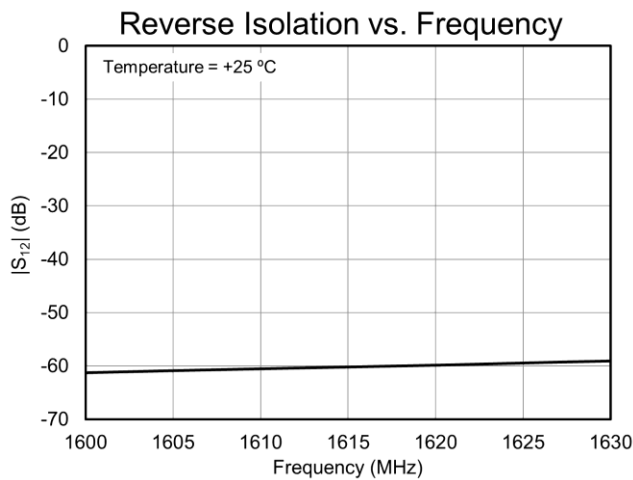
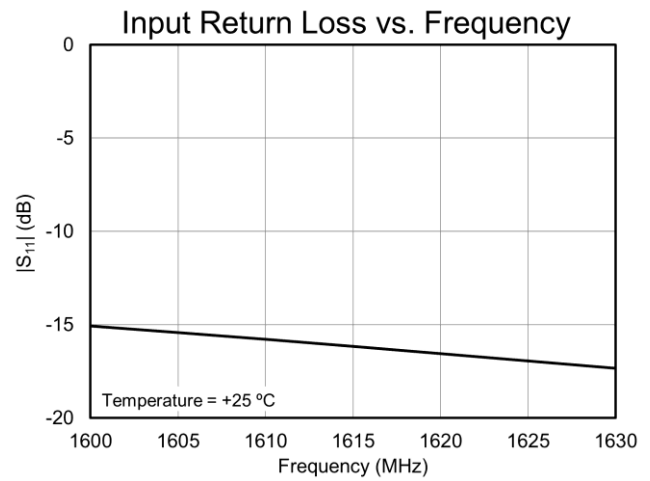
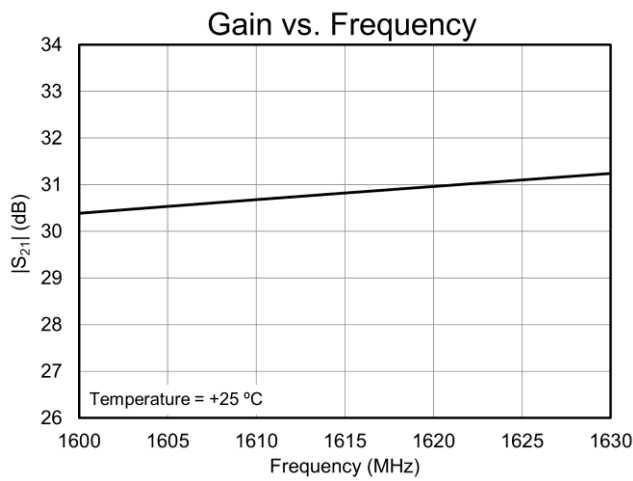

APPLICATION NOTE: QPA9903 – 1.616-1.626GHz Reference Design

2

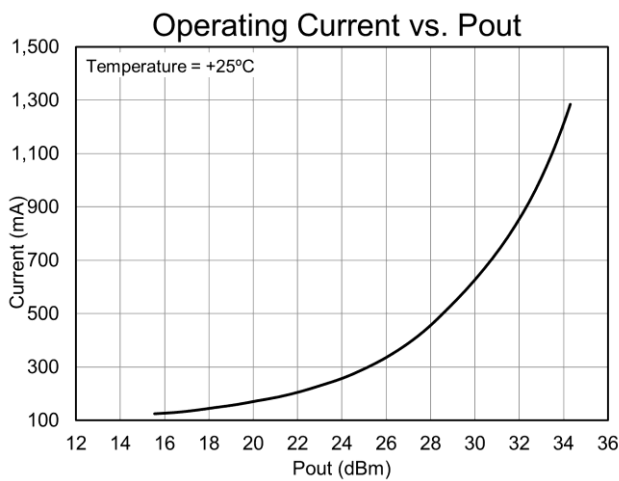
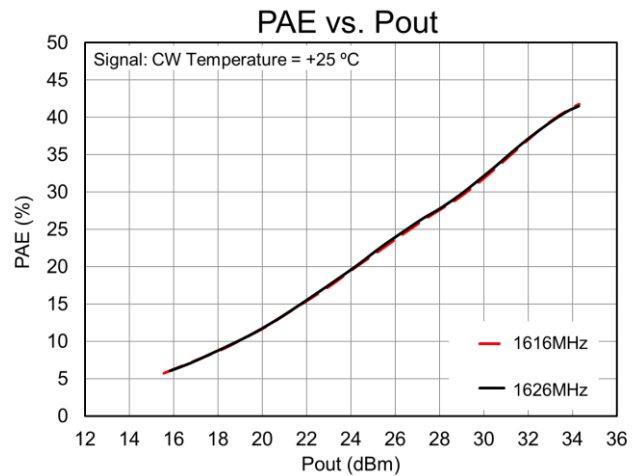
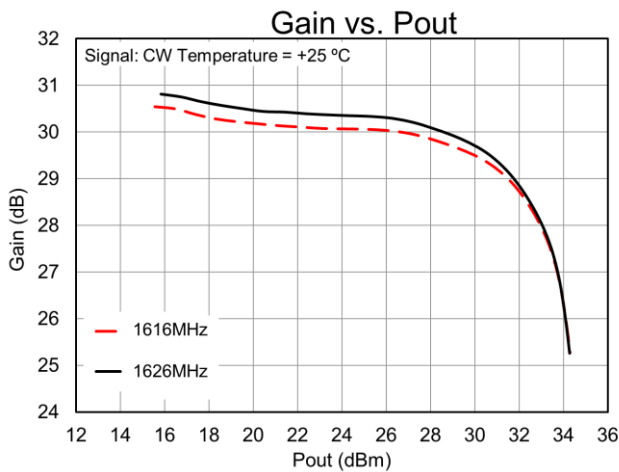
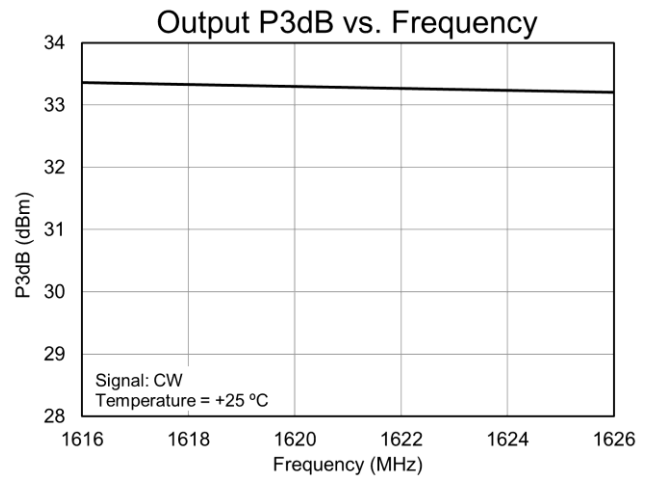
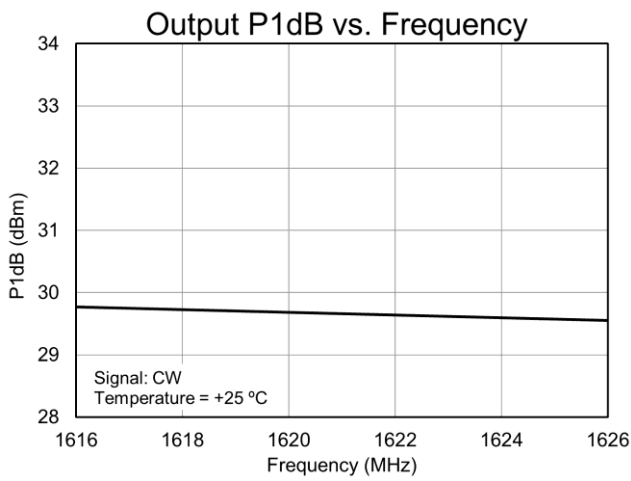

APPLICATION NOTE: QPA9903 – 1.616-1.626GHz Reference Design

## Evaluation Board Information

### Evaluation Board and Schematic

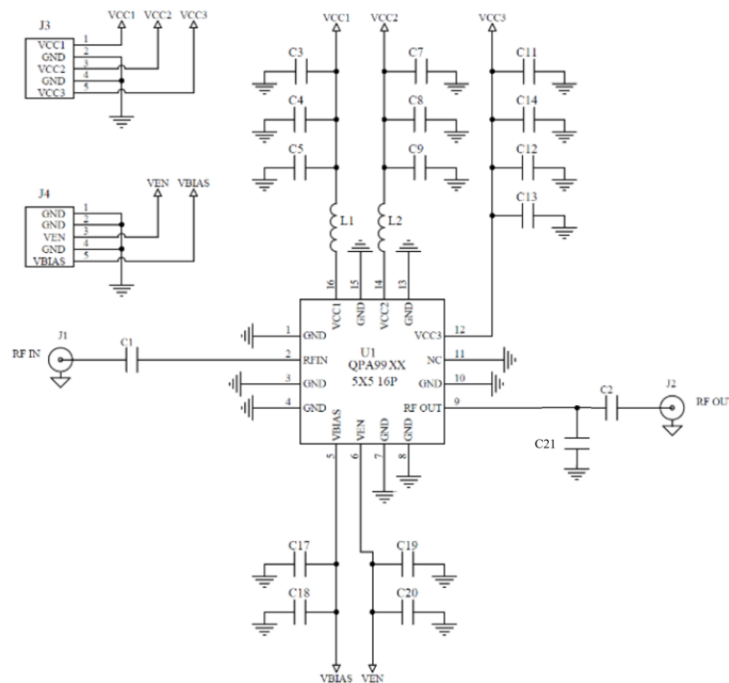
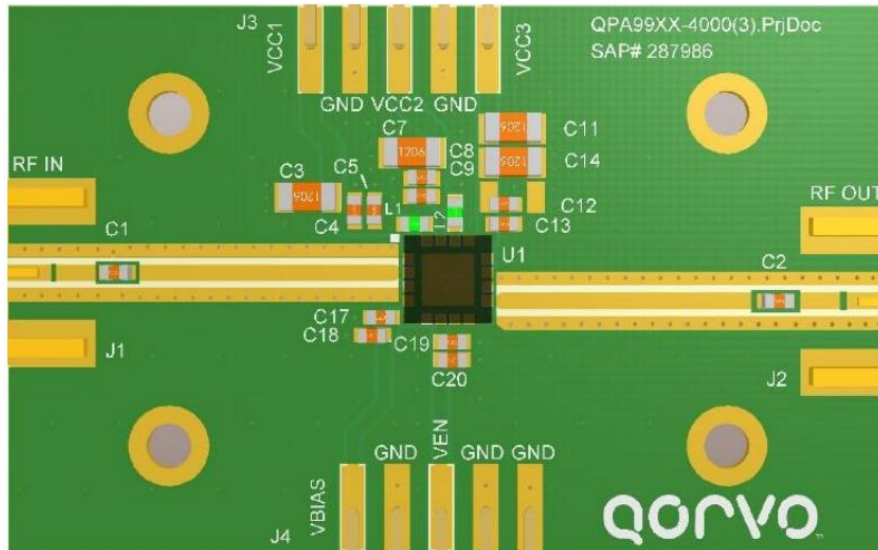

**Notes:**

1. See Evaluation Board PCB Information section for material and stack-up.
2. 2.46mm from the right of U1

APPLICATION NOTE: QPA9903 – 1.616-1.626GHz Reference Design

## Evaluation Board – Bill of Material

Reference Des.	Value	Description	Manuf.	Part Number
n/a	n/a	Printed Circuit Board		
U1	n/a	Amplifier, QPA9940 2300-2400MHz, High-Efficiency	Qorvo	QPA9940
C1, C2	100 pF	CAP,100 pF, 0603, 5%, 50V, C0G	Various	
C5, C9, C13, C17, C19	1000 pF	CAP,1000 pF, 0603, 5%, 50V, C0G	Various	
C4, C8, C12, C18, C20	0.1 $\mu$ F	CAP,0.1 $\mu$ F, 0603, 10%, 50V, X7R	Various	
C3, C7, C14	10 $\mu$ F	CAP, 10 $\mu$ F, 1206, 25V	Various	
C21	1.8 pF	CAP ,1.6 pF, 0603, $\pm$ 0.1 pF	Various	
L1, L2	0 $\Omega$	RES 0 $\Omega$ , 0603, 1/16W, Chip	Various	

APPLICATION NOTE: QPA9903 – 1.616-1.626GHz Reference Design

## Additional Information

For information on ESD, Soldering Profiles, Packaging Standards, Handling and Assembly, please contact Qorvo for general guidelines.

## Contact Information

For the latest specifications, additional product information, worldwide sales and distribution locations:

**Web:** [www.qorvo.com](http://www.qorvo.com)

**Tel:** 1-844-890-8163

**Email:** [customer.support@qorvo.com](mailto:customer.support@qorvo.com)

## Important Notice

The information contained in this Data Sheet and any associated documents (“Data Sheet Information”) is believed to be reliable; however, Qorvo makes no warranties regarding the Data Sheet Information and assumes no responsibility or liability whatsoever for the use of said information. All Data Sheet Information is subject to change without notice. Customers should obtain and verify the latest relevant Data Sheet Information before placing orders for Qorvo® products. Data Sheet Information or the use thereof does not grant, explicitly, implicitly or otherwise any rights or licenses to any third party with respect to patents or any other intellectual property whether with regard to such Data Sheet Information itself or anything described by such information.

DATA SHEET INFORMATION DOES NOT CONSTITUTE A WARRANTY WITH RESPECT TO THE PRODUCTS DESCRIBED HEREIN, AND QORVO HEREBY DISCLAIMS ANY AND ALL WARRANTIES WITH RESPECT TO SUCH PRODUCTS WHETHER EXPRESS OR IMPLIED BY LAW, COURSE OF DEALING, COURSE OF PERFORMANCE, USAGE OF TRADE OR OTHERWISE, INCLUDING THE IMPLIED WARRANTIES OF MERCHANTABILITY AND FITNESS FOR A PARTICULAR PURPOSE. Without limiting the generality of the foregoing, Qorvo® products are not warranted or authorized for use as critical components in medical, life-saving, or life-sustaining applications, or other applications where a failure would reasonably be expected to cause severe personal injury or death. Applications described in the Data Sheet Information are for illustrative purposes only. Customers are responsible for validating that a particular product described in the Data Sheet Information is suitable for use in a particular application.

© 2026 Qorvo US, Inc. All rights reserved. This document is subject to copyright laws in various jurisdictions worldwide and may not be reproduced or distributed, in whole or in part, without the express written consent of Qorvo US, Inc. | QORVO® is a registered trademark of Qorvo US, Inc.