

# QPL9503 – 4.8-5.0GHz Reference Design

## Product Overview

---

The QPL9503 is a flat-gain, high-linearity, ultra-low noise amplifier in a small 2 x 2 mm surface-mount package. The LNA provides a gain flatness of 2 dB (peak-to-peak) over a wide bandwidth from 3 to 6 GHz. At 5.5 GHz, the amplifier typically provides 21.6 dB gain, +35.5 dBm OIP3 at a 56mA bias setting, and 0.95 dB noise figure. The LNA can be biased from a single positive supply ranging from 3.3 to 5 volts. The device is housed in a green/RoHS-compliant industry-standard 2x2 mm package.

The QPL9503 is internally matched using a high performance E-pHEMT process and only requires five external components for operation from a single positive supply: an external RF choke and blocking/bypass capacitors and a bias resistor going to pin 1. This LNA integrates a shut-down biasing capability to allow for operation in TDD applications.

The QPL9503 is optimized for linear performance across the 3 to 6 GHz frequency band but can operate down to 600 MHz.

## Referenced Documents

The reference documents below take precedence over the contents of this application note and should always be consulted for the latest information.

QPL9503 Data Sheet.

## APPLICATION NOTE: QPL9503 – 4.8-5.0GHz Reference Design

## Application Electrical Performance

Qorvo Field and Factory Applications Engineers are available to provide technical assistance for determining appropriate matching networks for a particular application.

Parameter	Conditions	Typical Value			Units
Frequency		4800	4900	5000	MHz
Gain		21.4	22.0	22.2	dB
Input Return Loss		21.0	25.8	27.6	dB
Output Return Loss		11.9	22.0	15.2	dB
Noise Figure	EVB Trace Loss De-embedded	0.93	0.93	0.94	dB
Output P1dB		19.8	19.0	18.9	dBm
OIP3	Pout = +5dBm/tone, $\Delta f = 1$ MHz	34.9	34.2	33.6	dBm
Device Current, I <sub>DD</sub>	On State	56			mA
	Off State	3			mA

Test conditions unless otherwise noted: V<sub>DD</sub> = +5V, Temp = +25 °C, 50 Ω system.

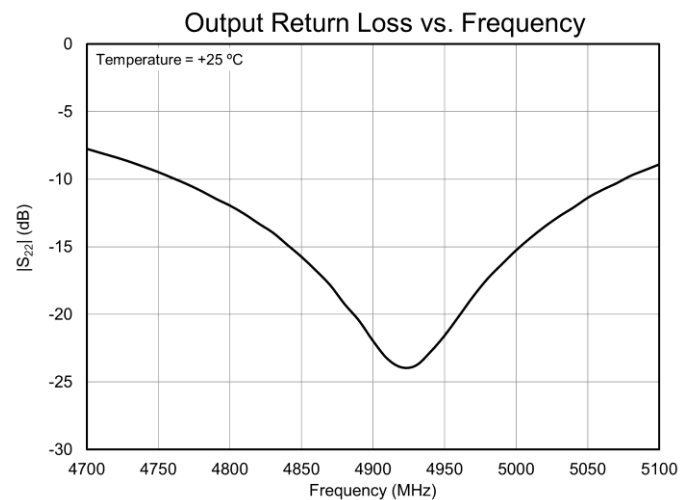
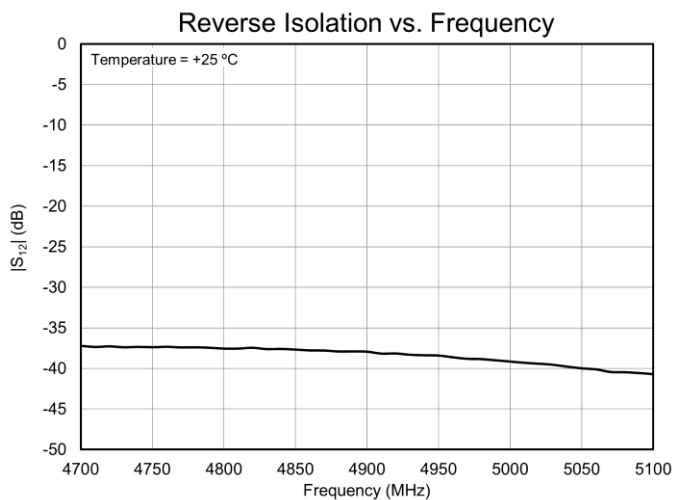
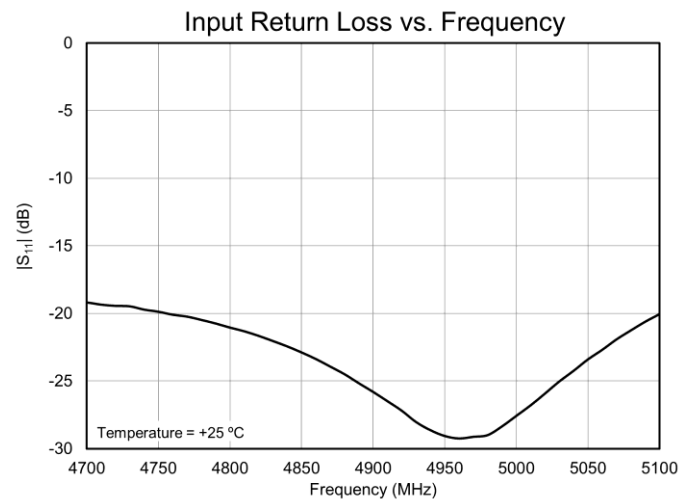
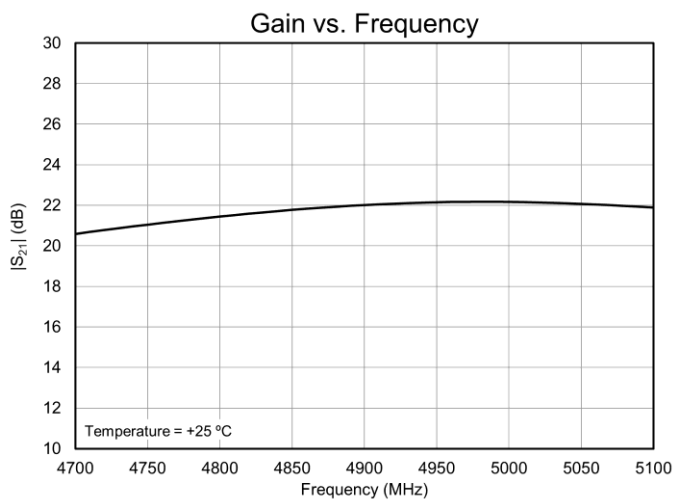

APPLICATION NOTE: QPL9503 – 4.8-5.0GHz Reference Design

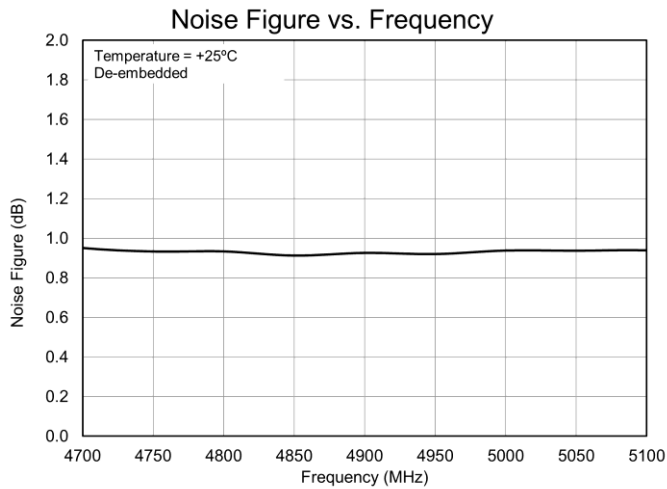
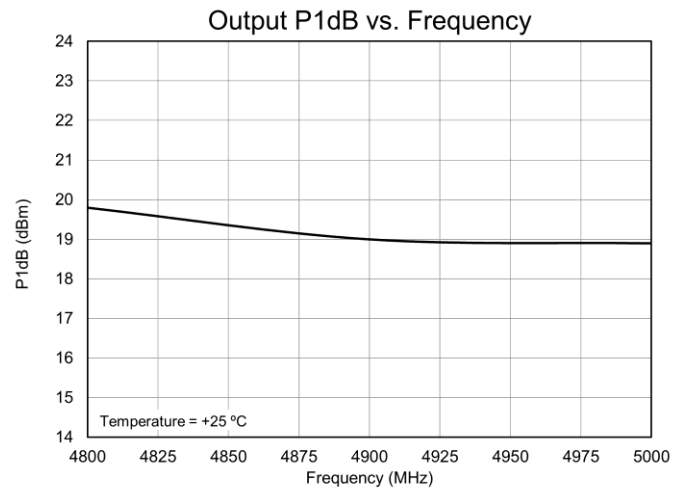
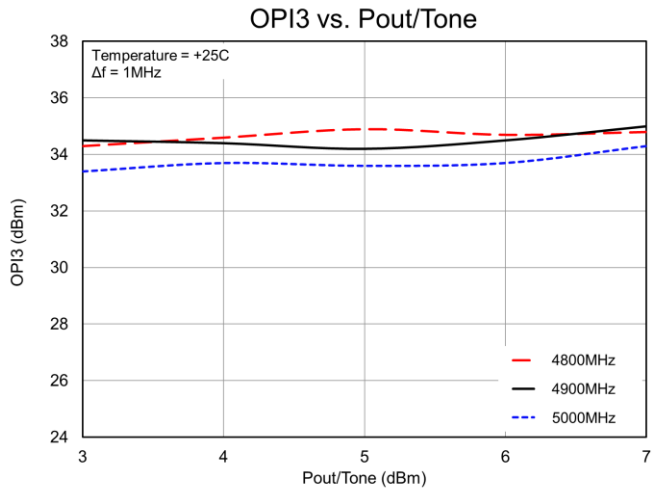

APPLICATION NOTE: QPL9503 – 4.8-5.0GHz Reference Design

## Evaluation Board Information

### Evaluation Board and Schematic

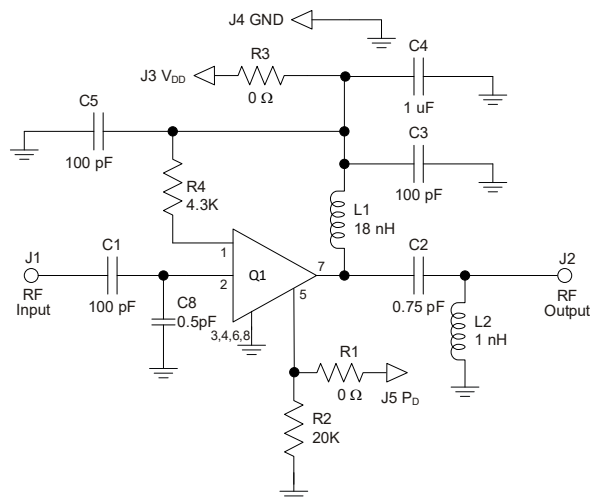
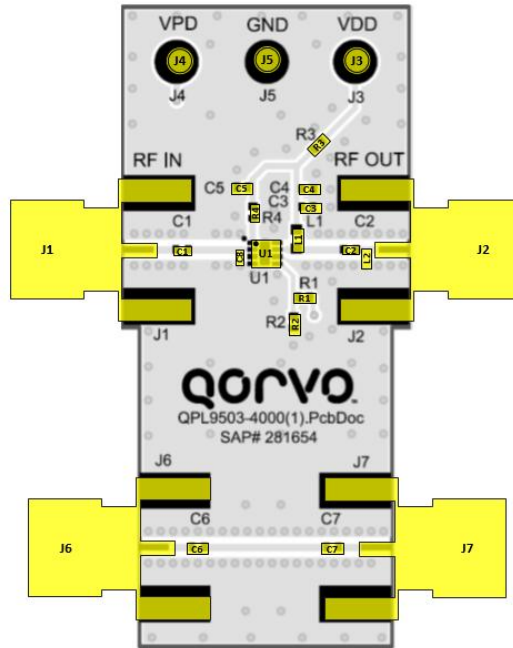

#### Notes:

1. See Evaluation Board PCB Information section for material and stack-up.
2. All components are of 0402 size unless stated on the schematic.
3. For TDD Applications: R2 = 20K & R1 = 0Ω
4. For FDD Applications: R2 = 20K 'OR' Pin 5 tied to ground. R1 = DNP/Omitted
5. A through line is included on the evaluation board to de-embed the board losses.
6. R4 sets the current draw. Can be changed for the desired bias point. Critical component placement locations:
7. Distance between U1 (right edge) and C8 (left edge):20 mils

APPLICATION NOTE: QPL9503 – 4.8-5.0GHz Reference Design

## Evaluation Board – Bill of Material

Reference Des.	Value	Description	Manuf.	Part Number
n/a	n/a	Printed Circuit Board		
U1	n/a	Ultra Low Noise, Flat Gain LNA	Qorvo	QPL9503
R4	4.3K	Resistor, Chip, 0402, 5%, 1/16W	various	
R2	20K	Resistor, chip, 0402, 5%, 1/16W	various	
R1, R3	0 $\Omega$	Resistor, Chip, 0402, 5%, 1/16W	various	
L1	18 nH	Inductor, 0402, 5%, coil	Coilcraft	0402CS-18NXJL
C2	0.75 pF	CAP, 0402, +/-0.1pF, 25V	AVX	04023J series
C8	0.5 pF	CAP, 0402, +/-0.05pF, 50V	AVX	04023J series
L2	1 nH	Inductor, 0402	AVX	04023J series
C4	1.0 uF	Cap., Chip, 0402, 10%, 10V, X5R	various	
C1, C3, C5, C6, C7	100 pF	Cap., Chip, 0402, 5%, 50V, NPO/COG	various	

APPLICATION NOTE: QPL9503 – 4.8-5.0GHz Reference Design

## Additional Information

For information on ESD, Soldering Profiles, Packaging Standards, Handling and Assembly, please contact Qorvo for general guidelines.

## Contact Information

For the latest specifications, additional product information, worldwide sales and distribution locations:

**Web:** [www.qorvo.com](http://www.qorvo.com)

**Tel:** 1-844-890-8163

**Email:** [customer.support@qorvo.com](mailto:customer.support@qorvo.com)

## Important Notice

The information contained in this Data Sheet and any associated documents (“Data Sheet Information”) is believed to be reliable; however, Qorvo makes no warranties regarding the Data Sheet Information and assumes no responsibility or liability whatsoever for the use of said information. All Data Sheet Information is subject to change without notice. Customers should obtain and verify the latest relevant Data Sheet Information before placing orders for Qorvo® products. Data Sheet Information or the use thereof does not grant, explicitly, implicitly or otherwise any rights or licenses to any third party with respect to patents or any other intellectual property whether with regard to such Data Sheet Information itself or anything described by such information.

DATA SHEET INFORMATION DOES NOT CONSTITUTE A WARRANTY WITH RESPECT TO THE PRODUCTS DESCRIBED HEREIN, AND QORVO HEREBY DISCLAIMS ANY AND ALL WARRANTIES WITH RESPECT TO SUCH PRODUCTS WHETHER EXPRESS OR IMPLIED BY LAW, COURSE OF DEALING, COURSE OF PERFORMANCE, USAGE OF TRADE OR OTHERWISE, INCLUDING THE IMPLIED WARRANTIES OF MERCHANTABILITY AND FITNESS FOR A PARTICULAR PURPOSE. Without limiting the generality of the foregoing, Qorvo® products are not warranted or authorized for use as critical components in medical, life-saving, or life-sustaining applications, or other applications where a failure would reasonably be expected to cause severe personal injury or death. Applications described in the Data Sheet Information are for illustrative purposes only. Customers are responsible for validating that a particular product described in the Data Sheet Information is suitable for use in a particular application.

© 2026 Qorvo US, Inc. All rights reserved. This document is subject to copyright laws in various jurisdictions worldwide and may not be reproduced or distributed, in whole or in part, without the express written consent of Qorvo US, Inc. | QORVO® is a registered trademark of Qorvo US, Inc.